



STB18NM60N, STF18NM60N, STP18NM60N, STW18NM60N

N-channel 600 V, 0.26 Ω typ., 13 A MDmesh™ II Power MOSFET
in D²PAK, TO-220FP, TO-220 and TO-247

Datasheet — production data

Features

Order codes	V _{DSS} (@T _{jmax})	R _{DS(on)} max.	I _D	P _{TOT}
STB18NM60N	650 V	< 0.285 Ω	13 A	110 W
STF18NM60N				30 W
STP18NM60N				110
STW18NM60N				

- 100% avalanche tested
- Low input capacitance and gate charge
- Low gate input resistance

Applications

- Switching applications

Description

These devices are N-channel Power MOSFETs developed using the second generation of MDmesh™ technology. This revolutionary Power MOSFET associates a vertical structure to the company's strip layout to yield one of the world's lowest on-resistance and gate charge. It is therefore suitable for the most demanding high efficiency converters.

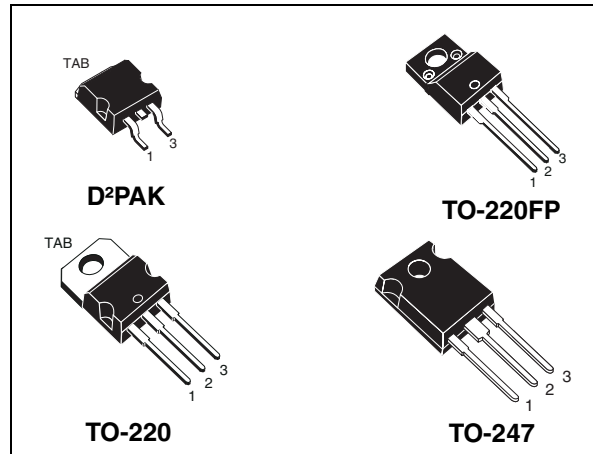

Figure 1. Internal schematic diagram

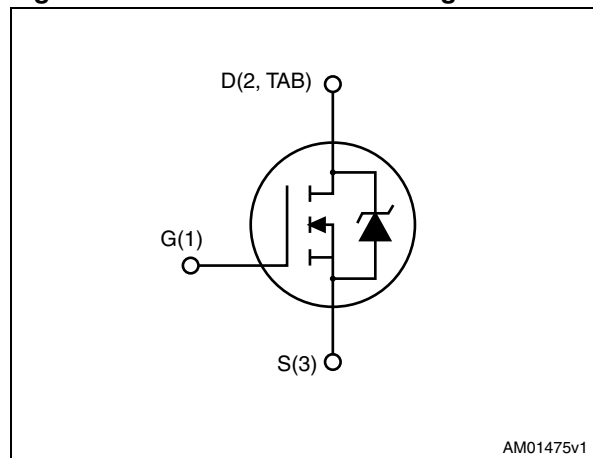

Table 1. Device summary

Order codes	Marking	Package	Packaging
STB18NM60N	18NM60N	D ² PAK	Tape and reel
STF18NM60N	18NM60N	TO-220FP	Tube
STP18NM60N	18NM60N	TO-220	Tube
STW18NM60N	18NM60N	TO-247	Tube

Contents

1	Electrical ratings	3
2	Electrical characteristics	4
2.1	Electrical characteristics (curves)	6
3	Test circuits	9
4	Package mechanical data	10
5	Packaging mechanical data	18
6	Revision history	20

1 Electrical ratings

Table 2. Absolute maximum ratings

Symbol	Parameter	Value		Unit
		D ² PAK, TO-220,TO-247	TO-220FP	
V _{DS}	Drain-source voltage	600		V
V _{GS}	Gate- source voltage	± 25		
I _D	Drain current (continuous) at T _C = 25 °C	13	13 ⁽¹⁾	A
I _D	Drain current (continuous) at T _C = 100 °C	8.2	8.2 ⁽¹⁾	A
I _{DM} ⁽²⁾	Drain current (pulsed)	52	52 ⁽¹⁾	A
P _{TOT}	Total dissipation at T _C = 25 °C	110	30	W
I _{AR}	Avalanche current, repetitive or not-repetitive (pulse width limited by T _J max)	4.5		A
E _{AS}	Single pulse avalanche energy (starting T _J = 25 °C, I _D = I _{AR} , V _{DD} = 50 V)	350		mJ
dv/dt ⁽³⁾	Peak diode recovery voltage slope	15		V/ns
V _{ISO}	Insulation withstand voltage (RMS) from all three leads to external heat sink (t=1 s; T _C =25 °C)		2500	V
T _J T _{stg}	Operating junction temperature Storage temperature	-55 to 150		°C

- Limited by maximum junction temperature.
- Pulse width limited by safe operating area.
- I_{SD} ≤ 13 A, di/dt ≤ 400 A/μs, V_{DD} ≤ 80 % V_{(BR)DSS}, V_{DS(peak)} ≤ V_{(BR)DSS}

Table 3. Thermal data

Symbol	Parameter	D ² PAK	TO-220	TO-247	TO-220FP	Unit
R _{thj-case}	Thermal resistance junction-case max	1.14			4.17	°C/W
R _{thj-amb}	Thermal resistance junction-amb max		62.5	50	62.5	
R _{thj-pcb} ⁽¹⁾	Thermal resistance junction-pcb max	30				

- When mounted on 1inch² FR-4 board, 2 oz Cu.

2 Electrical characteristics

($T_{CASE}=25\text{ °C}$ unless otherwise specified)

Table 4. On/off states

Symbol	Parameter	Test conditions	Min.	Typ.	Max.	Unit
$V_{(BR)DSS}$	Drain-source breakdown voltage	$I_D = 1\text{ mA}$, $V_{GS} = 0$	600			V
I_{DSS}	Zero gate voltage drain current ($V_{GS} = 0$)	$V_{DS} = 600\text{ V}$ $V_{DS} = 600\text{ V}$, $T_J = 125\text{ °C}$			1 10	μA μA
I_{GSS}	Gate body leakage current ($V_{DS} = 0$)	$V_{GS} = \pm 25\text{ V}$			± 100	nA
$V_{GS(th)}$	Gate threshold voltage	$V_{DS} = V_{GS}$, $I_D = 250\text{ }\mu\text{A}$	2	3	4	V
$R_{DS(on)}$	Static drain-source on-resistance	$V_{GS} = 10\text{ V}$, $I_D = 6.5\text{ A}$		0.260	0.285	Ω

Table 5. Dynamic

Symbol	Parameter	Test conditions	Min.	Typ.	Max.	Unit
C_{iss}	Input capacitance	$V_{DS} = 50\text{ V}$, $f = 1\text{ MHz}$, $V_{GS} = 0$	-	1000	-	pF
C_{oss}	Output capacitance			60		pF
C_{rss}	Reverse transfer capacitance			3		pF
$C_{oss\text{ eq.}}^{(1)}$	Output equivalent capacitance	$V_{DS} = 0$, to 480 V , $V_{GS} = 0$	-	225	-	pF
R_g	Intrinsic resistance	$f = 1\text{ MHz}$ open drain	-	3.5	-	Ω
Q_g	Total gate charge	$V_{DD} = 480\text{ V}$, $I_D = 13\text{ A}$	-	35	-	nC
Q_{gs}	Gate-source charge	$V_{GS} = 10\text{ V}$		6		nC
Q_{gd}	Gate-drain charge	(see Figure 19)		20		nC

1. $C_{oss\text{ eq.}}$ is defined as a constant equivalent capacitance giving the same charging time as C_{oss} when V_{DS} increases from 0 to 80% V_{DS} .

Table 6. Switching times

Symbol	Parameter	Test conditions	Min.	Typ.	Max.	Unit
$t_{d(on)}$	Turn-on delay time	$V_{DD} = 300\text{ V}$, $I_D = 6.5\text{ A}$, $R_G = 4.7\text{ }\Omega$, $V_{GS} = 10\text{ V}$ (see Figure 18)	-	12	-	ns
t_r	Rise time			15		ns
$t_{d(off)}$	Turn-off delay time			55		ns
t_f	Fall time			25		ns

Table 7. Source drain diode

Symbol	Parameter	Test conditions	Min.	Typ.	Max.	Unit
I_{SD}	Source-drain current		-		13	A
$I_{SDM}^{(1)}$	Source-drain current (pulsed)		-		52	A
$V_{SD}^{(2)}$	Forward on voltage	$I_{SD} = 13\text{ A}$, $V_{GS}=0$	-		1.6	V
t_{rr}	Reverse recovery time	$I_{SD} = 13\text{ A}$, $di/dt = 100\text{ A}/\mu\text{s}$, $V_{DD} = 60\text{ V}$	-	300		ns
Q_{rr}	Reverse recovery charge	(see Figure 20)		4.0		μC
I_{RRM}	Reverse recovery current			25		A
t_{rr}	Reverse recovery time	$V_{DD} = 60\text{ V}$	-	360		ns
Q_{rr}	Reverse recovery charge	$di/dt = 100\text{ A}/\mu\text{s}$, $I_{SD} = 13\text{ A}$		4.5		μC
I_{RRM}	Reverse recovery current	$T_j = 150^\circ\text{C}$ (see Figure 20)		25		A

1. Pulse width limited by safe operating area
2. Pulsed: pulse duration = 300 μs , duty cycle 1.5%

2.1 Electrical characteristics (curves)

Figure 2. Safe operating area for TO-220 and D²PAK

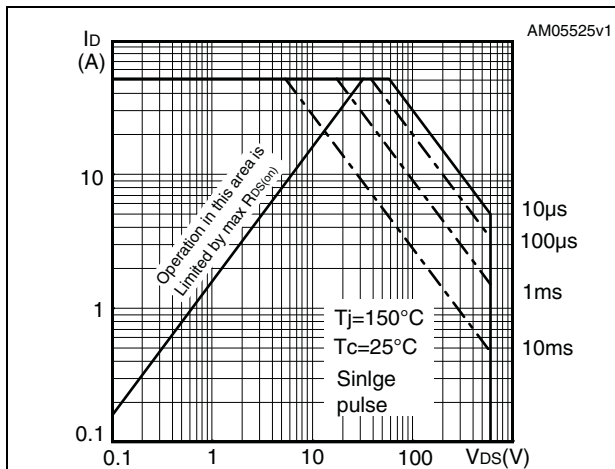

Figure 3. Thermal impedance for TO-220 and D²PAK

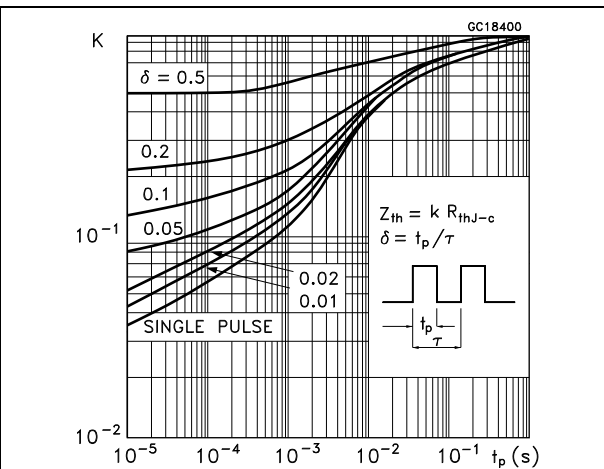

Figure 4. Safe operating area for TO-220FP

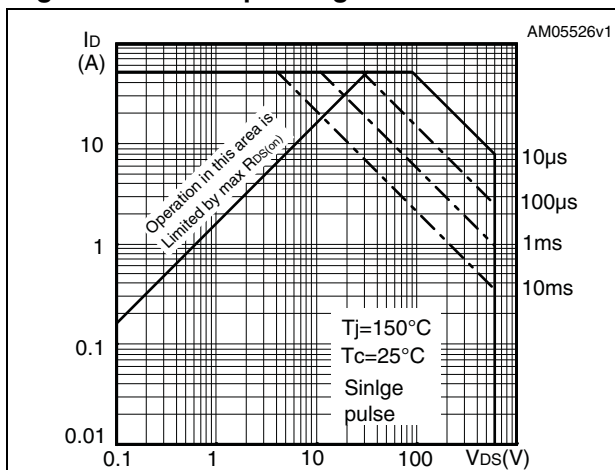

Figure 5. Thermal impedance for TO-220FP

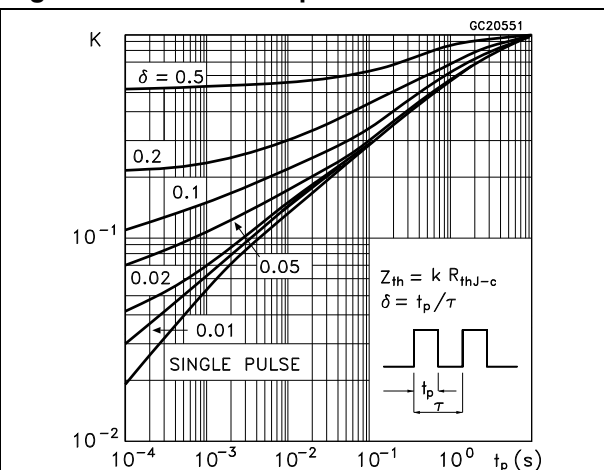

Figure 6. Safe operating area for TO-247

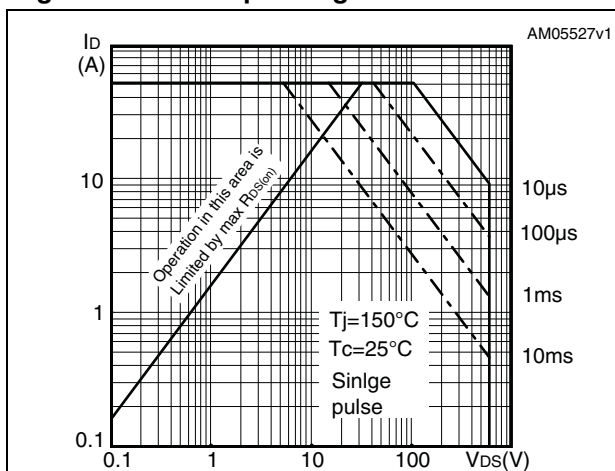

Figure 7. Thermal impedance for TO-247

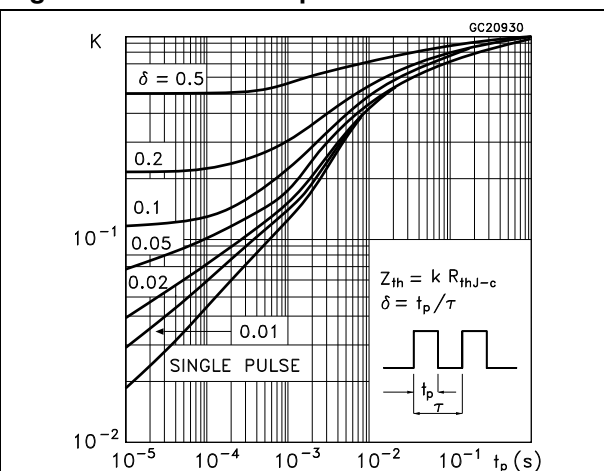

Figure 8. Output characteristics

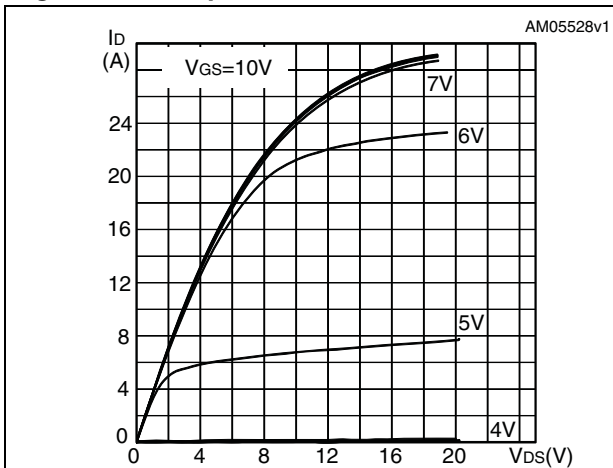

Figure 9. Transfer characteristics

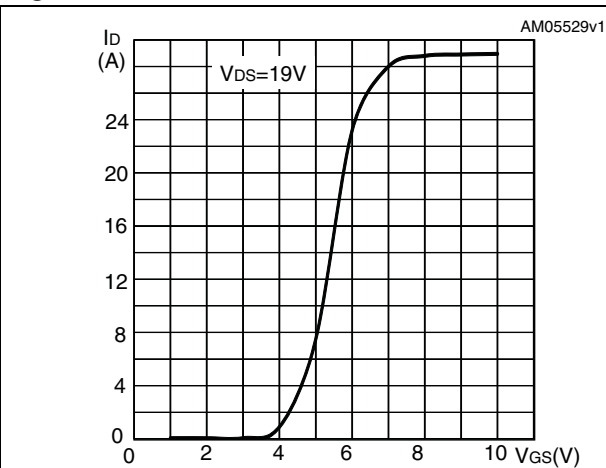

Figure 10. Static drain-source on resistance

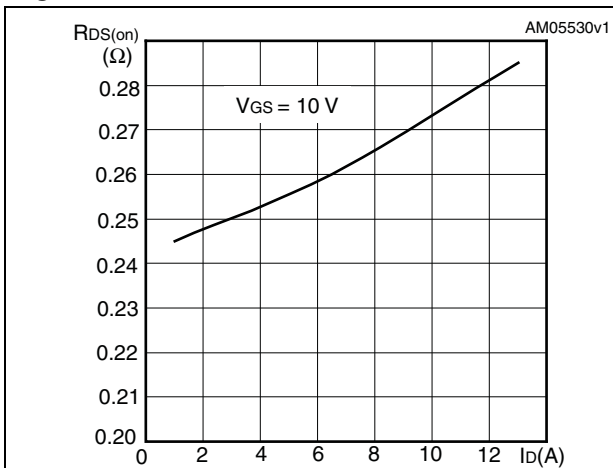

Figure 11. Gate charge vs gate-source voltage

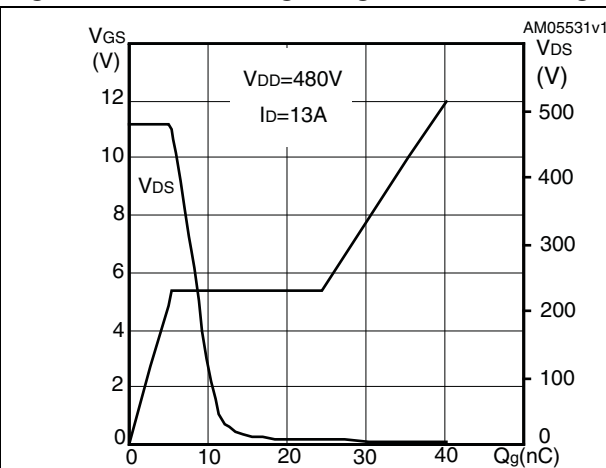

Figure 12. Capacitance variations

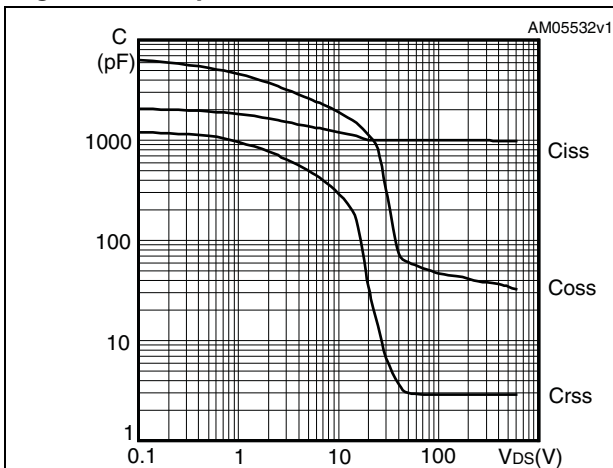

Figure 13. Output capacitance stored energy

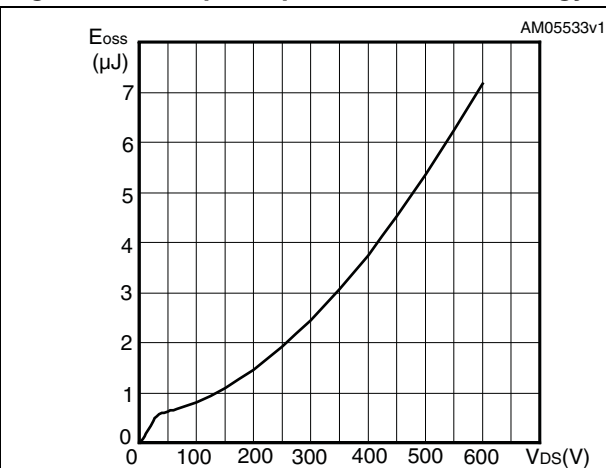

Figure 14. Normalized gate threshold voltage vs temperature

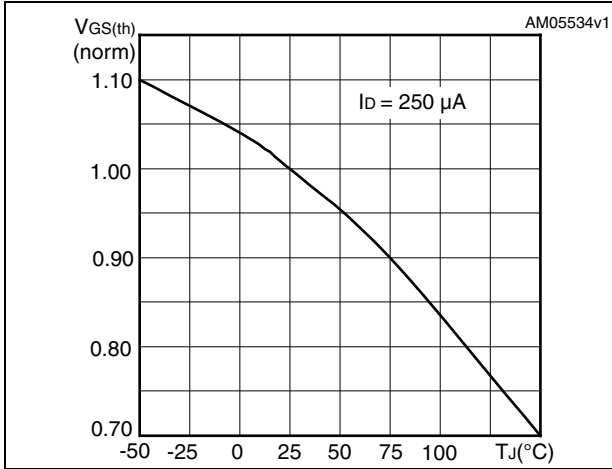

Figure 15. Normalized on resistance vs temperature

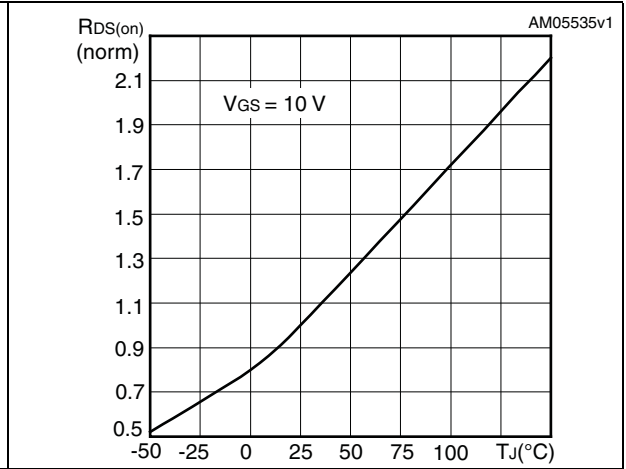

Figure 16. Normalized B_{VDS} vs temperature

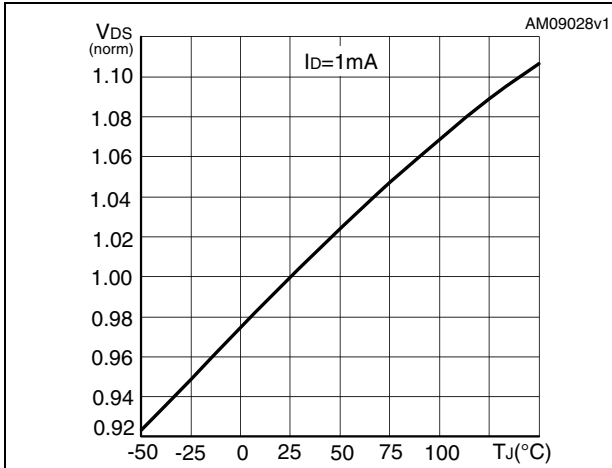
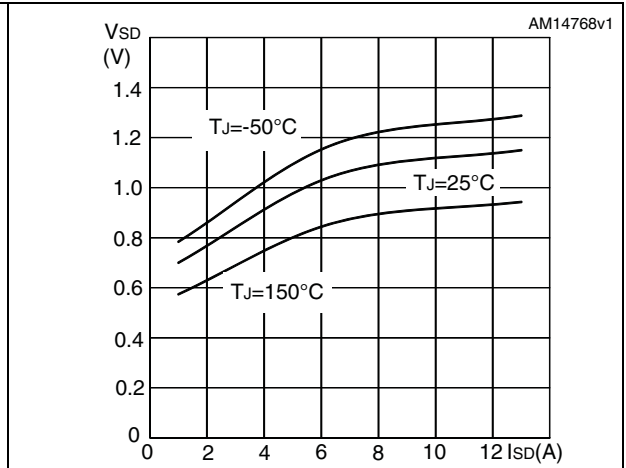

Figure 17. Source-drain diode forward vs temperature



3 Test circuits

Figure 18. Switching times test circuit for resistive load



AM01468v1

Figure 19. Gate charge test circuit



AM01469v1

Figure 20. Test circuit for inductive load switching and diode recovery times



AM01470v1

Figure 21. Unclamped inductive load test circuit



AM01471v1

Figure 22. Unclamped inductive waveform



AM01472v1

Figure 23. Switching time waveform



AM01473v1

4 Package mechanical data

In order to meet environmental requirements, ST offers these devices in different grades of ECOPACK[®] packages, depending on their level of environmental compliance. ECOPACK[®] specifications, grade definitions and product status are available at: www.st.com. ECOPACK is an ST trademark.

Table 8. D²PAK (TO-263) mechanical data

Dim.	mm		
	Min.	Typ.	Max.
A	4.40		4.60
A1	0.03		0.23
b	0.70		0.93
b2	1.14		1.70
c	0.45		0.60
c2	1.23		1.36
D	8.95		9.35
D1	7.50		
E	10		10.40
E1	8.50		
e		2.54	
e1	4.88		5.28
H	15		15.85
J1	2.49		2.69
L	2.29		2.79
L1	1.27		1.40
L2	1.30		1.75
R		0.4	
V2	0°		8°

Figure 24. D²PAK (TO-263) drawing



Figure 25. D²PAK footprint^(a)



a. All dimension are in millimeters

Table 9. TO-220FP mechanical data

Dim.	mm		
	Min.	Typ.	Max.
A	4.4		4.6
B	2.5		2.7
D	2.5		2.75
E	0.45		0.7
F	0.75		1
F1	1.15		1.70
F2	1.15		1.70
G	4.95		5.2
G1	2.4		2.7
H	10		10.4
L2		16	
L3	28.6		30.6
L4	9.8		10.6
L5	2.9		3.6
L6	15.9		16.4
L7	9		9.3
Dia	3		3.2

Figure 26. TO-220FP drawing



Table 10. TO-220 type A mechanical data

Dim.	mm		
	Min.	Typ.	Max.
A	4.40		4.60
b	0.61		0.88
b1	1.14		1.70
c	0.48		0.70
D	15.25		15.75
D1		1.27	
E	10		10.40
e	2.40		2.70
e1	4.95		5.15
F	1.23		1.32
H1	6.20		6.60
J1	2.40		2.72
L	13		14
L1	3.50		3.93
L20		16.40	
L30		28.90	
ØP	3.75		3.85
Q	2.65		2.95

Figure 27. TO-220 type A drawing

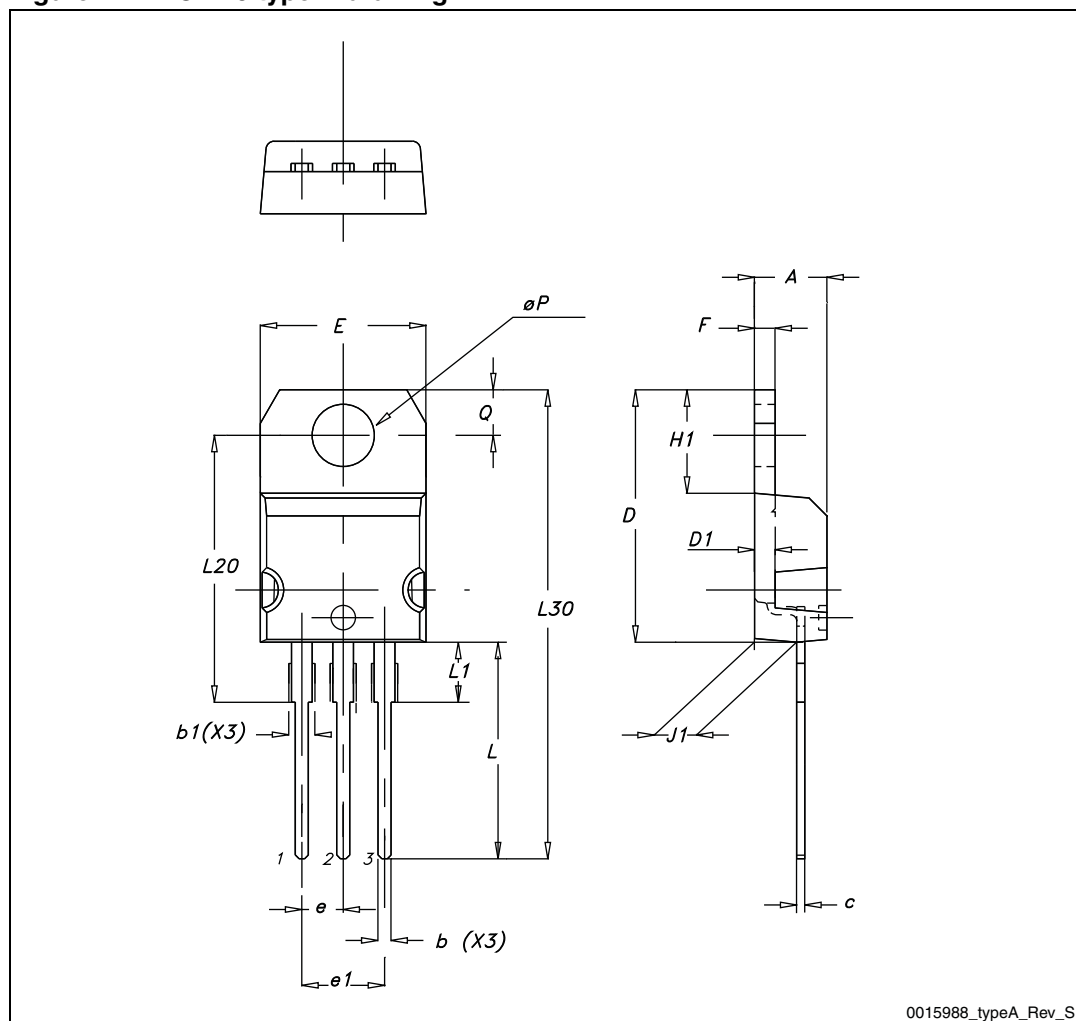

Table 11. TO-247 mechanical data

Dim.	mm.		
	Min.	Typ.	Max.
A	4.85		5.15
A1	2.20		2.60
b	1.0		1.40
b1	2.0		2.40
b2	3.0		3.40
c	0.40		0.80
D	19.85		20.15
E	15.45		15.75
e	5.30	5.45	5.60
L	14.20		14.80
L1	3.70		4.30
L2		18.50	
ØP	3.55		3.65
ØR	4.50		5.50
S	5.30	5.50	5.70

Figure 28. TO-247 drawing



5 Packaging mechanical data

Table 12. D²PAK (TO-263) tape and reel mechanical data

Tape			Reel		
Dim.	mm		Dim.	mm	
	Min.	Max.		Min.	Max.
A0	10.5	10.7	A		330
B0	15.7	15.9	B	1.5	
D	1.5	1.6	C	12.8	13.2
D1	1.59	1.61	D	20.2	
E	1.65	1.85	G	24.4	26.4
F	11.4	11.6	N	100	
K0	4.8	5.0	T		30.4
P0	3.9	4.1			
P1	11.9	12.1		Base qty	1000
P2	1.9	2.1		Bulk qty	1000
R	50				
T	0.25	0.35			
W	23.7	24.3			

Figure 29. Tape



AM08852v2

Figure 30. Reel

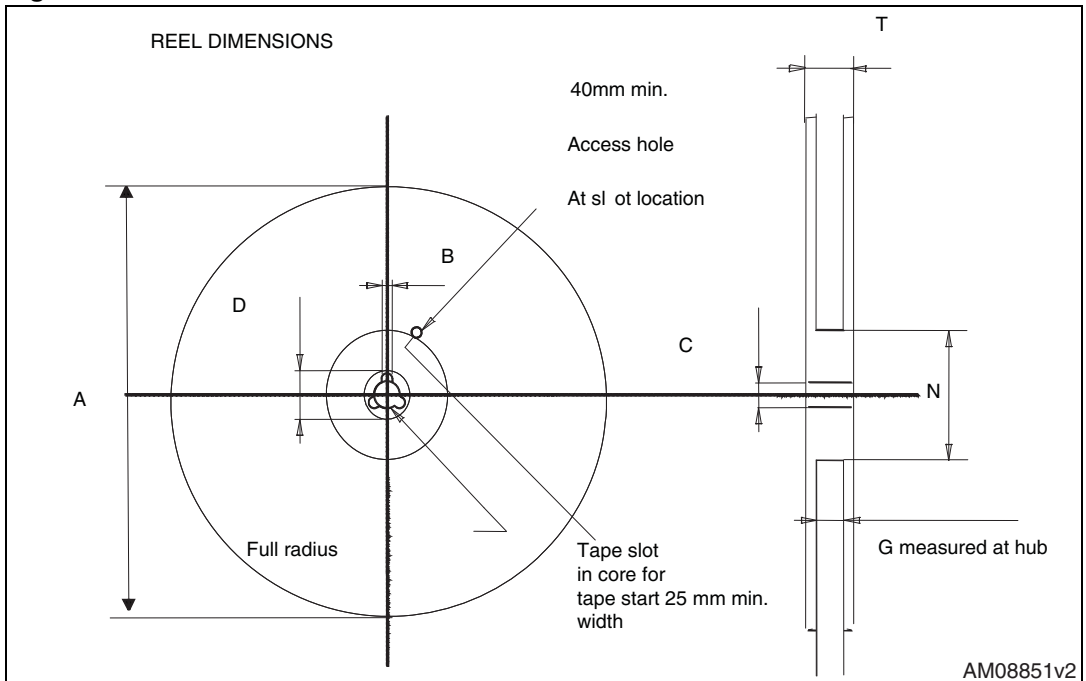

AM08851v2

6 Revision history

Table 13. Document revision history

Date	Revision	Changes
15-Jun-2009	1	First release
11-Nov-2009	2	<ul style="list-style-type: none">– Added $R_{DS(on)}$ typical value– Added new package, mechanical data: I²PAK– Document status promoted from preliminary data to datasheet
06-Oct-2010	3	Inserted new value in Table 5 .
01-Oct-2012	4	Updated title and description on the cover page. Updated figures 10 , 11 , 14 , 15 and 16 . Updated Section 4: Package mechanical data and Section 5: Packaging mechanical data .

Please Read Carefully:

Information in this document is provided solely in connection with ST products. STMicroelectronics NV and its subsidiaries ("ST") reserve the right to make changes, corrections, modifications or improvements, to this document, and the products and services described herein at any time, without notice.

All ST products are sold pursuant to ST's terms and conditions of sale.

Purchasers are solely responsible for the choice, selection and use of the ST products and services described herein, and ST assumes no liability whatsoever relating to the choice, selection or use of the ST products and services described herein.

No license, express or implied, by estoppel or otherwise, to any intellectual property rights is granted under this document. If any part of this document refers to any third party products or services it shall not be deemed a license grant by ST for the use of such third party products or services, or any intellectual property contained therein or considered as a warranty covering the use in any manner whatsoever of such third party products or services or any intellectual property contained therein.

UNLESS OTHERWISE SET FORTH IN ST'S TERMS AND CONDITIONS OF SALE ST DISCLAIMS ANY EXPRESS OR IMPLIED WARRANTY WITH RESPECT TO THE USE AND/OR SALE OF ST PRODUCTS INCLUDING WITHOUT LIMITATION IMPLIED WARRANTIES OF MERCHANTABILITY, FITNESS FOR A PARTICULAR PURPOSE (AND THEIR EQUIVALENTS UNDER THE LAWS OF ANY JURISDICTION), OR INFRINGEMENT OF ANY PATENT, COPYRIGHT OR OTHER INTELLECTUAL PROPERTY RIGHT.

UNLESS EXPRESSLY APPROVED IN WRITING BY TWO AUTHORIZED ST REPRESENTATIVES, ST PRODUCTS ARE NOT RECOMMENDED, AUTHORIZED OR WARRANTED FOR USE IN MILITARY, AIR CRAFT, SPACE, LIFE SAVING, OR LIFE SUSTAINING APPLICATIONS, NOR IN PRODUCTS OR SYSTEMS WHERE FAILURE OR MALFUNCTION MAY RESULT IN PERSONAL INJURY, DEATH, OR SEVERE PROPERTY OR ENVIRONMENTAL DAMAGE. ST PRODUCTS WHICH ARE NOT SPECIFIED AS "AUTOMOTIVE GRADE" MAY ONLY BE USED IN AUTOMOTIVE APPLICATIONS AT USER'S OWN RISK.

Resale of ST products with provisions different from the statements and/or technical features set forth in this document shall immediately void any warranty granted by ST for the ST product or service described herein and shall not create or extend in any manner whatsoever, any liability of ST.

ST and the ST logo are trademarks or registered trademarks of ST in various countries.

Information in this document supersedes and replaces all information previously supplied.

The ST logo is a registered trademark of STMicroelectronics. All other names are the property of their respective owners.

© 2012 STMicroelectronics - All rights reserved

STMicroelectronics group of companies

Australia - Belgium - Brazil - Canada - China - Czech Republic - Finland - France - Germany - Hong Kong - India - Israel - Italy - Japan - Malaysia - Malta - Morocco - Philippines - Singapore - Spain - Sweden - Switzerland - United Kingdom - United States of America

www.st.com



Mouser Electronics

Authorized Distributor

Click to View Pricing, Inventory, Delivery & Lifecycle Information:

[STMicroelectronics:](#)

[STF18NM60N](#) [STP18NM60N](#) [STW18NM60N](#)