

Features

- High frequency operation
- Lower C_{RES} / C_{IES} ratio (no cross-conduction susceptibility)
- Very soft ultra fast recovery antiparallel diode

Applications

- High frequency motor controls, inverters, UPS
- HF, SMPS and PFC in both hard switch and resonant topologies

Description

This IGBT utilizes the advanced Power MESH™ process resulting in an excellent trade-off between switching performance and low on-state behavior.

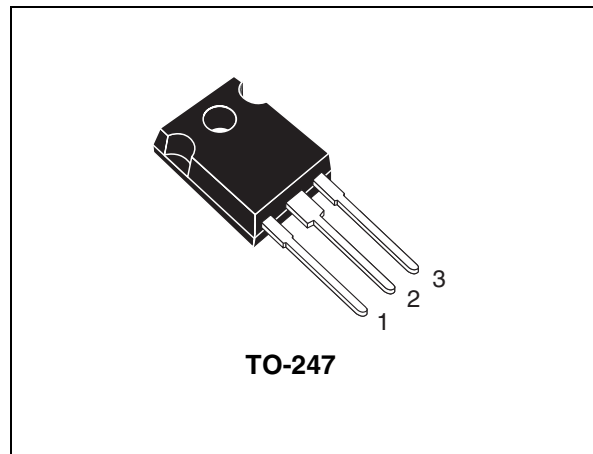

Figure 1. Internal schematic diagram

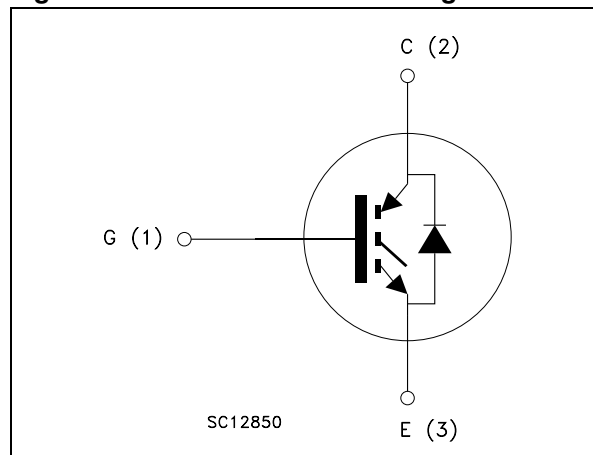

Table 1. Device summary

Order code	Marking	Package	Packaging
STGW30NC60WD	GW30NC60WD	TO-247	Tube

Contents

1	Electrical ratings	3
2	Electrical characteristics	4
	2.1 Electrical characteristics (curves)	7
3	Test circuit	10
4	Package mechanical data	11
5	Revision history	13

1 Electrical ratings

Table 2. Absolute maximum ratings

Symbol	Parameter	Value	Unit
V_{CES}	Collector-emitter voltage ($V_{GE} = 0$)	600	V
$I_C^{(1)}$	Collector current (continuous) at 25 °C	60	A
$I_C^{(1)}$	Collector current (continuous) at 100 °C	30	A
$I_{CP}^{(2)}$	Collector current (pulsed)	150	A
$I_{CL}^{(3)}$	Turn-off latching current	150	A
V_{GE}	Gate-emitter voltage	± 20	V
I_F	Diode RMS forward current at $T_C = 25$ °C	30	A
I_{FSM}	Surge not repetitive forward current $t_p = 10$ ms sinusoidal	120	A
P_{TOT}	Total dissipation at $T_C = 25$ °C	200	W
T_{stg}	Storage temperature	- 55 to 150	°C
T_j	Operating junction temperature		

1. Calculated according to the iterative formula:

$$I_C(T_C) = \frac{T_{j(max)} - T_C}{R_{thj-c} \times V_{CE(sat)(max)}(T_{j(max)}, I_C(T_C))}$$

2. Pulse width limited by max junction temperature
 3. $V_{CLAMP} = 80\%$ (V_{CES}), $V_{GE} = 15$ V, $R_G = 10$ Ω, $T_J = 150$ °C

Table 3. Thermal resistance

Symbol	Parameter	Value	Unit
$R_{thj-case}$	Thermal resistance junction-case IGBT max.	0.63	°C/W
	Thermal resistance junction-case diode max.	1.5	°C/W
$R_{thj-amb}$	Thermal resistance junction-ambient max.	50	°C/W

2 Electrical characteristics

($T_{CASE} = 25\text{ °C}$ unless otherwise specified)

Table 4. Static electrical characteristics

Symbol	Parameter	Test conditions	Min.	Typ.	Max.	Unit
$V_{(BR)CES}$	Collector-emitter breakdown voltage ($V_{GE} = 0$)	$I_C = 1\text{ mA}$	600			V
$V_{CE(sat)}$	Collector-emitter saturation voltage	$V_{GE} = 15\text{ V}$, $I_C = 20\text{ A}$ $V_{GE} = 15\text{ V}$, $I_C = 20\text{ A}$, $T_C = 125\text{ °C}$		2.1 1.8	2.5	V V
$V_{GE(th)}$	Gate threshold voltage	$V_{CE} = V_{GE}$, $I_C = 250\mu\text{A}$	3.75		5.75	V
I_{CES}	Collector cut-off current ($V_{GE} = 0$)	$V_{CE} = 600\text{ V}$ $V_{CE} = 600\text{ V}$, $T_C = 125\text{ °C}$			250 1	μA mA
I_{GES}	Gate-emitter leakage current ($V_{CE} = 0$)	$V_{GE} = \pm 20\text{ V}$			± 100	nA
g_{fs}	Forward transconductance	$V_{CE} = 15\text{ V}$, $I_C = 20\text{ A}$		15		S

Table 5. Dynamic electrical characteristics

Symbol	Parameter	Test conditions	Min.	Typ.	Max.	Unit
C_{ies}	Input capacitance	$V_{CE} = 25\text{ V}$, $f = 1\text{ MHz}$, $V_{GE} = 0$		2080		pF
C_{oes}	Output capacitance			175		pF
C_{res}	Reverse transfer capacitance			52		pF
Q_g	Total gate charge	$V_{CE} = 390\text{ V}$, $I_C = 20\text{ A}$, $V_{GE} = 15\text{ V}$, (see Figure 18)		102	140	nC
Q_{ge}	Gate-emitter charge			17.5		nC
Q_{gc}	Gate-collector charge			47		nC

Table 6. Switching on/off (inductive load)

Symbol	Parameter	Test conditions	Min.	Typ.	Max.	Unit
$t_{d(on)}$	Turn-on delay time	$V_{CC} = 390\text{ V}$, $I_C = 20\text{ A}$		29.5		ns
t_r	Current rise time	$R_G = 10\ \Omega$, $V_{GE} = 15\text{ V}$,		12		ns
$(di/dt)_{on}$	Turn-on current slope	(see Figure 17)		1640		A/ μ s
$t_{d(on)}$	Turn-on delay time	$V_{CC} = 390\text{ V}$, $I_C = 20\text{ A}$		29		ns
t_r	Current rise time	$R_G = 10\ \Omega$, $V_{GE} = 15\text{ V}$,		13.5		ns
$(di/dt)_{on}$	Turn-on current slope	$T_C = 125\text{ }^\circ\text{C}$ (see Figure 17)		1600		A/ μ s
$t_r(V_{off})$	Off voltage rise time	$V_{CC} = 390\text{ V}$, $I_C = 20\text{ A}$,		19.5		ns
$t_{d(off)}$	Turn-off delay time	$R_{GE} = 10\ \Omega$, $V_{GE} = 15\text{ V}$		118		ns
t_f	Current fall time	(see Figure 17)		27		ns
$t_r(V_{off})$	Off voltage rise time	$V_{CC} = 390\text{ V}$, $I_C = 20\text{ A}$,		46		ns
$t_{d(off)}$	Turn-off delay time	$R_{GE} = 10\ \Omega$, $V_{GE} = 15\text{ V}$,		151		ns
t_f	Current fall time	$T_C = 125\text{ }^\circ\text{C}$ (see Figure 17)		38		ns

Table 7. Switching energy (inductive load)

Symbol	Parameter	Test conditions	Min.	Typ.	Max.	Unit
$E_{on}^{(1)}$	Turn-on switching losses	$V_{CC} = 390\text{ V}$, $I_C = 20\text{ A}$		305		μ J
E_{off}	Turn-off switching losses	$R_G = 10\ \Omega$, $V_{GE} = 15\text{ V}$,		181		μ J
E_{ts}	Total switching losses	(see Figure 19)		486		μ J
$E_{on}^{(1)}$	Turn-on switching losses	$V_{CC} = 390\text{ V}$, $I_C = 20\text{ A}$		455		μ J
E_{off}	Turn-off switching losses	$R_G = 10\ \Omega$, $V_{GE} = 15\text{ V}$,		355		μ J
E_{ts}	Total switching losses	$T_C = 125\text{ }^\circ\text{C}$ (see Figure 19)		810		μ J

1. E_{on} is the turn-on losses when a typical diode is used in the test circuit in Figure 19. If the IGBT is offered in a package with a co-pak diode, the co-pak diode is used as external diode. IGBTs & Diode are at the same temperature (25°C and 125°C). E_{on} include diode recovery energy.

Table 8. Collector-emitter diode

Symbol	Parameter	Test conditions	Min.	Typ.	Max.	Unit
V_F	Forward on-voltage	$I_F = 20 \text{ A}$		2.6		V
		$I_F = 20 \text{ A}, T_C = 125 \text{ }^\circ\text{C}$		1.6		V
t_{rr}	Reverse recovery time	$I_F = 20 \text{ A}, V_R = 50 \text{ V},$		40		ns
Q_{rr}	Reverse recovery charge	$di/dt = 100 \text{ A}/\mu\text{s}$		50		nC
I_{rrm}	Reverse recovery current	(see Figure 20)		2.5		A
t_{rr}	Reverse recovery time	$I_F = 20 \text{ A}, V_R = 50 \text{ V},$		80		ns
Q_{rr}	Reverse recovery charge	$T_C = 125 \text{ }^\circ\text{C}, di/dt = 100$		180		nC
I_{rrm}	Reverse recovery current	$\text{A}/\mu\text{s}$ (see Figure 20)		4.5		A

2.1 Electrical characteristics (curves)

Figure 2. Output characteristics

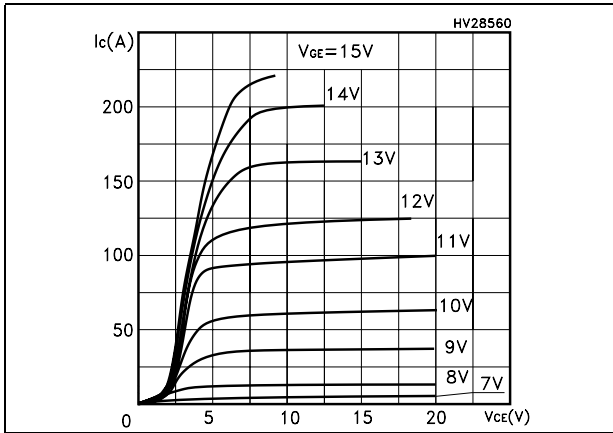

Figure 3. Transfer characteristics

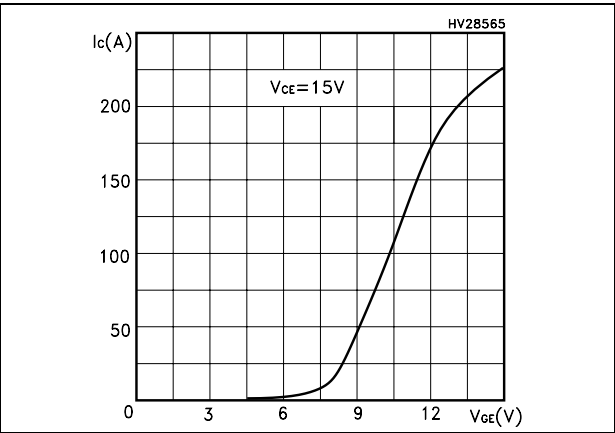

Figure 4. Transconductance

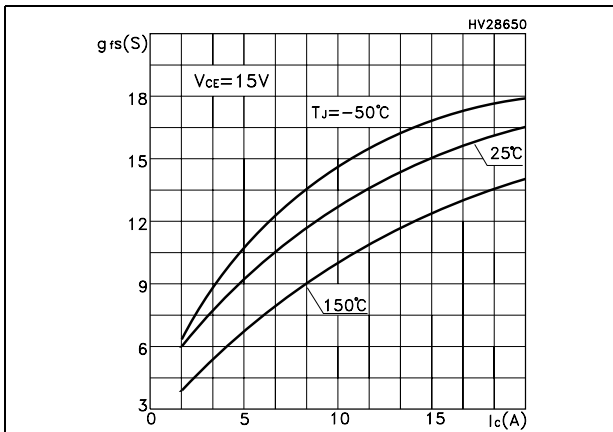

Figure 5. Collector-emitter on voltage vs temperature

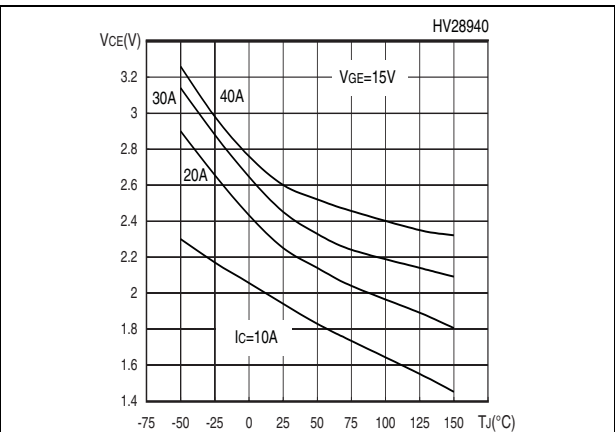

Figure 6. Gate charge vs gate-source voltage

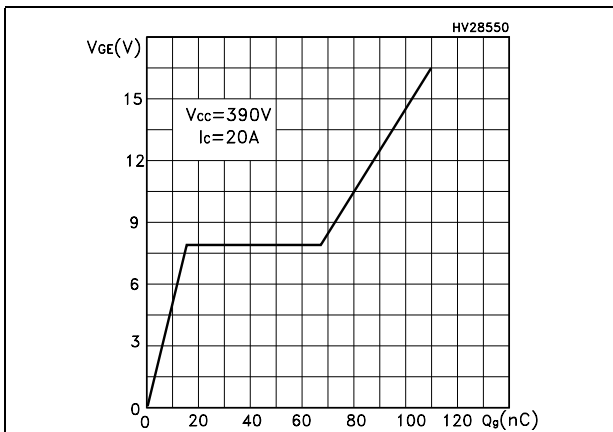

Figure 7. Capacitance variations

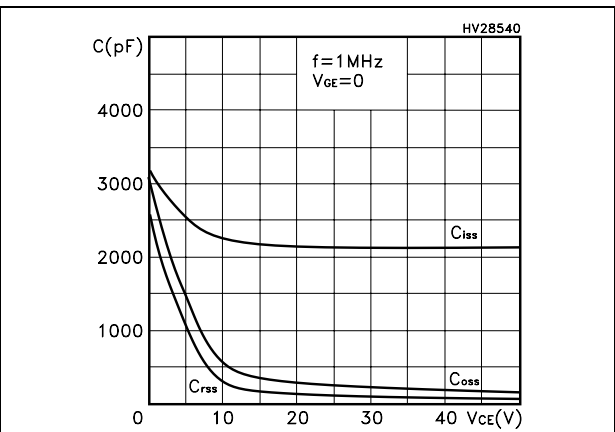

Figure 8. Normalized gate threshold voltage vs temperature

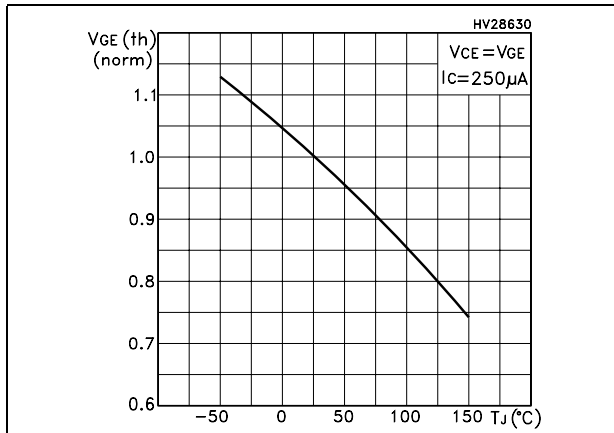

Figure 9. Collector-emitter on voltage vs collector current

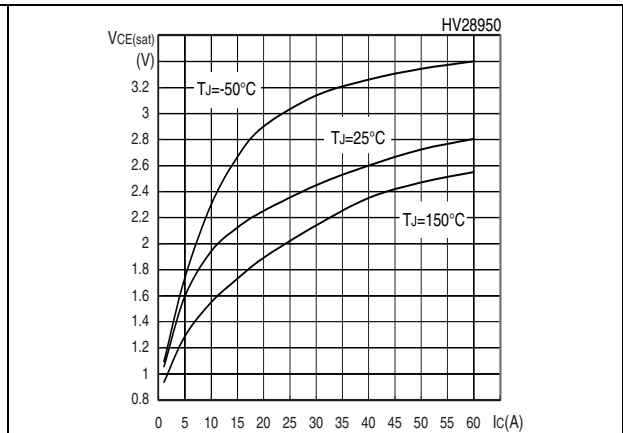

Figure 10. Normalized breakdown voltage vs temperature

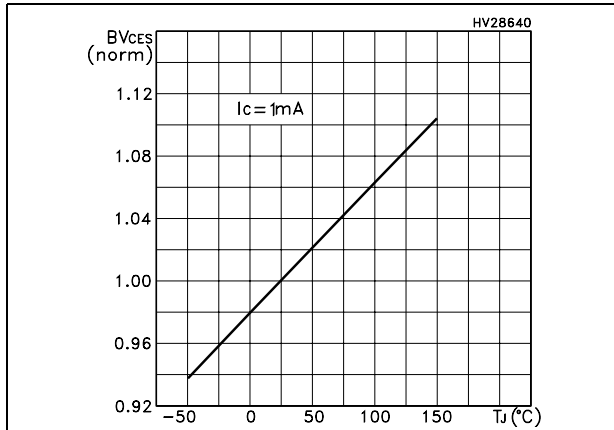

Figure 11. Switching losses vs temperature

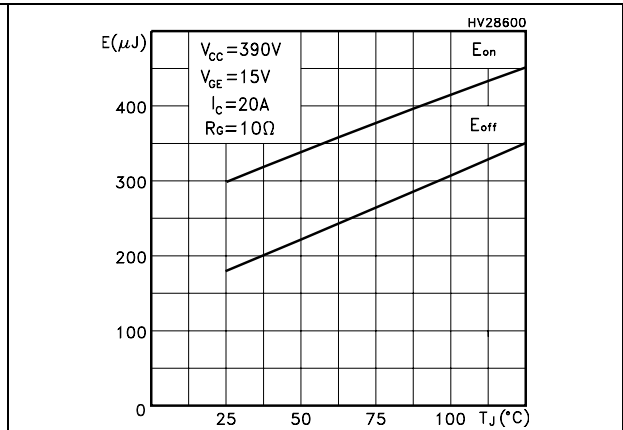

Figure 12. Switching losses vs gate resistance

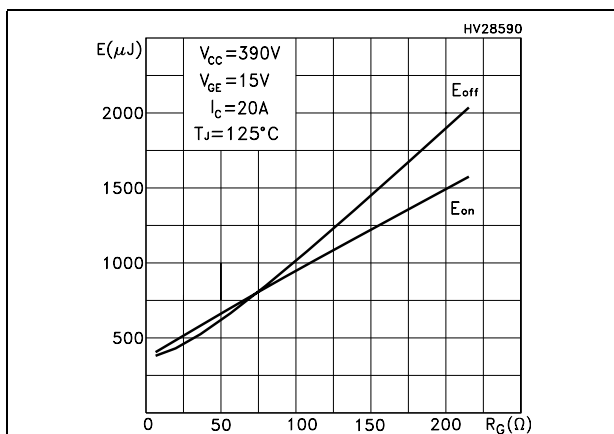

Figure 13. Switching losses vs collector current

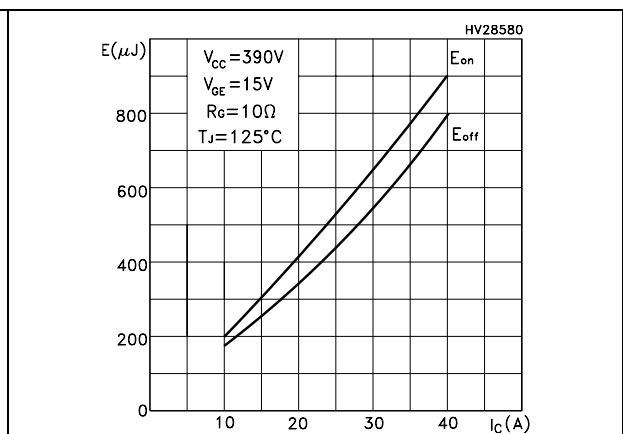

Figure 14. Thermal impedance

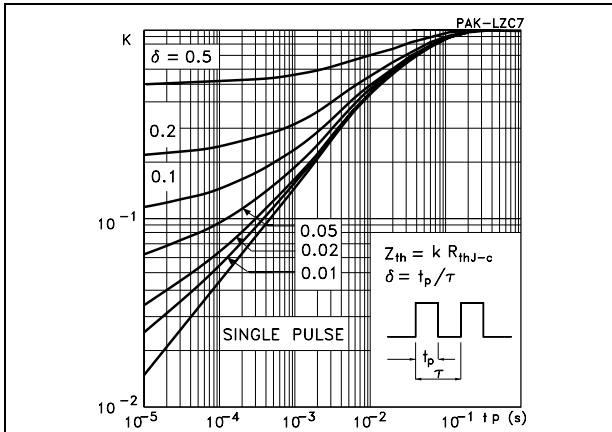

Figure 15. Turn-off SOA

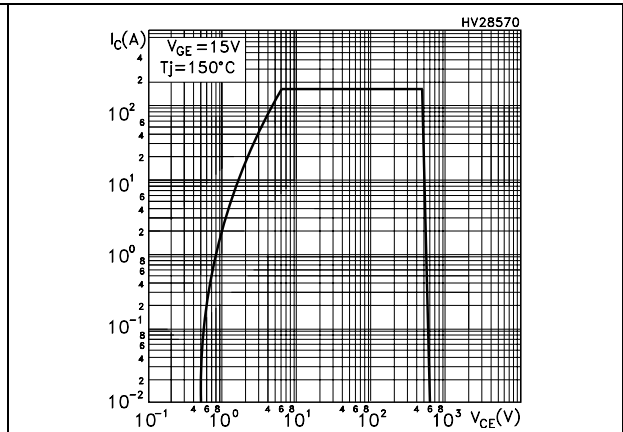
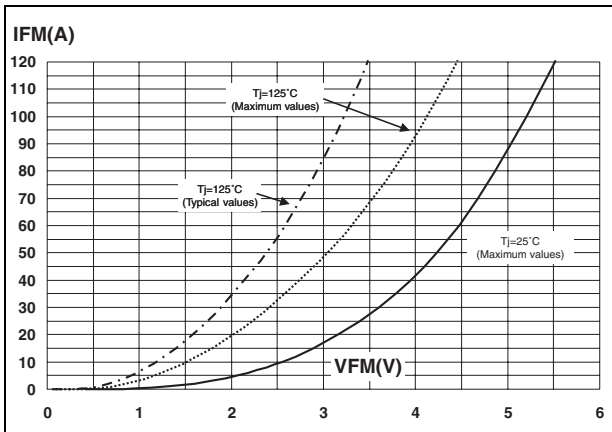

Figure 16. Emitter-collector diode characteristics



3 Test circuit

Figure 17. Test circuit for inductive load switching



Figure 18. Gate charge test circuit

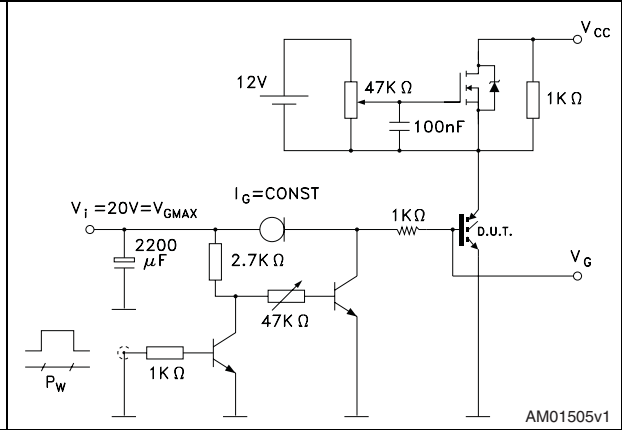

Figure 19. Switching waveform

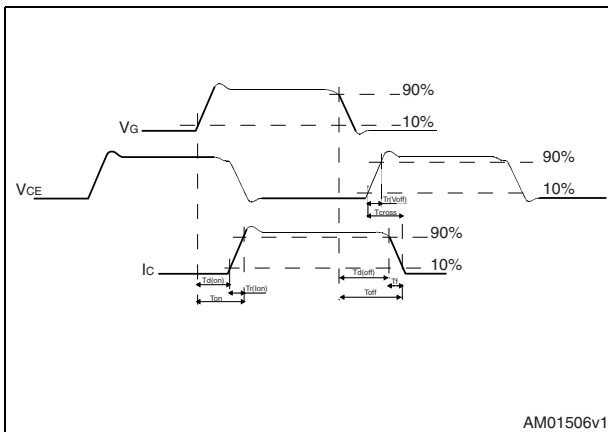
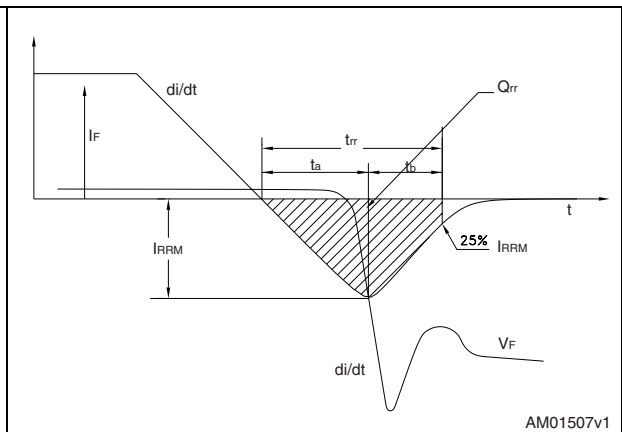

Figure 20. Diode recovery time waveform



4 Package mechanical data

In order to meet environmental requirements, ST offers these devices in ECOPACK® packages. These packages have a Lead-free second level interconnect. The category of second level interconnect is marked on the package and on the inner box label, in compliance with JEDEC Standard JESD97. The maximum ratings related to soldering conditions are also marked on the inner box label. ECOPACK is an ST trademark. ECOPACK specifications are available at: www.st.com

TO-247 Mechanical data

Dim.	mm.		
	Min.	Typ	Max.
A	4.85		5.15
A1	2.20		2.60
b	1.0		1.40
b1	2.0		2.40
b2	3.0		3.40
c	0.40		0.80
D	19.85		20.15
E	15.45		15.75
e		5.45	
L	14.20		14.80
L1	3.70		4.30
L2		18.50	
øP	3.55		3.65
øR	4.50		5.50
S		5.50	

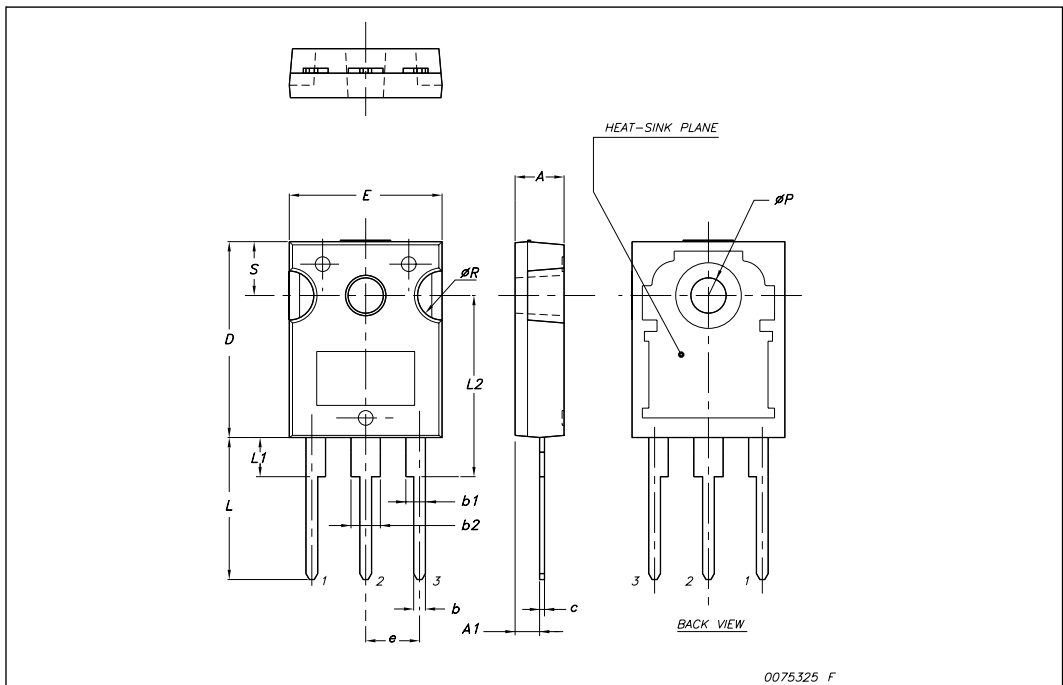

5 Revision history

Table 9. Document revision history

Date	Revision	Changes
21-Nov-2005	1	Initial release.
29-Nov-2005	2	Modified <i>Figure 5</i> and <i>Figure 6</i>
06-Mar-2006	3	New template
12-Jul-2007	4	Corrected <i>Figure 11</i> , <i>Figure 12</i> , <i>Figure 13</i>
11-Nov-2008	5	<i>Figure 16</i> has been updated.

Please Read Carefully:

Information in this document is provided solely in connection with ST products. STMicroelectronics NV and its subsidiaries ("ST") reserve the right to make changes, corrections, modifications or improvements, to this document, and the products and services described herein at any time, without notice.

All ST products are sold pursuant to ST's terms and conditions of sale.

Purchasers are solely responsible for the choice, selection and use of the ST products and services described herein, and ST assumes no liability whatsoever relating to the choice, selection or use of the ST products and services described herein.

No license, express or implied, by estoppel or otherwise, to any intellectual property rights is granted under this document. If any part of this document refers to any third party products or services it shall not be deemed a license grant by ST for the use of such third party products or services, or any intellectual property contained therein or considered as a warranty covering the use in any manner whatsoever of such third party products or services or any intellectual property contained therein.

UNLESS OTHERWISE SET FORTH IN ST'S TERMS AND CONDITIONS OF SALE ST DISCLAIMS ANY EXPRESS OR IMPLIED WARRANTY WITH RESPECT TO THE USE AND/OR SALE OF ST PRODUCTS INCLUDING WITHOUT LIMITATION IMPLIED WARRANTIES OF MERCHANTABILITY, FITNESS FOR A PARTICULAR PURPOSE (AND THEIR EQUIVALENTS UNDER THE LAWS OF ANY JURISDICTION), OR INFRINGEMENT OF ANY PATENT, COPYRIGHT OR OTHER INTELLECTUAL PROPERTY RIGHT.

UNLESS EXPRESSLY APPROVED IN WRITING BY AN AUTHORIZED ST REPRESENTATIVE, ST PRODUCTS ARE NOT RECOMMENDED, AUTHORIZED OR WARRANTED FOR USE IN MILITARY, AIR CRAFT, SPACE, LIFE SAVING, OR LIFE SUSTAINING APPLICATIONS, NOR IN PRODUCTS OR SYSTEMS WHERE FAILURE OR MALFUNCTION MAY RESULT IN PERSONAL INJURY, DEATH, OR SEVERE PROPERTY OR ENVIRONMENTAL DAMAGE. ST PRODUCTS WHICH ARE NOT SPECIFIED AS "AUTOMOTIVE GRADE" MAY ONLY BE USED IN AUTOMOTIVE APPLICATIONS AT USER'S OWN RISK.

Resale of ST products with provisions different from the statements and/or technical features set forth in this document shall immediately void any warranty granted by ST for the ST product or service described herein and shall not create or extend in any manner whatsoever, any liability of ST.

ST and the ST logo are trademarks or registered trademarks of ST in various countries.

Information in this document supersedes and replaces all information previously supplied.

The ST logo is a registered trademark of STMicroelectronics. All other names are the property of their respective owners.

© 2008 STMicroelectronics - All rights reserved

STMicroelectronics group of companies

Australia - Belgium - Brazil - Canada - China - Czech Republic - Finland - France - Germany - Hong Kong - India - Israel - Italy - Japan - Malaysia - Malta - Morocco - Singapore - Spain - Sweden - Switzerland - United Kingdom - United States of America

www.st.com

Mouser Electronics

Authorized Distributor

Click to View Pricing, Inventory, Delivery & Lifecycle Information:

[STMicroelectronics:](#)

[STGW30NC60WD](#)