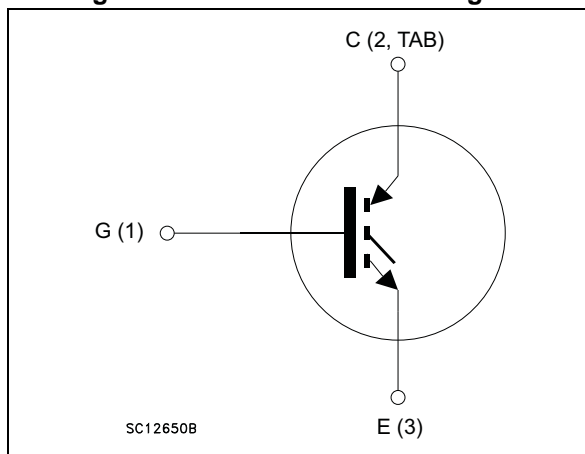

Figure 1. Internal schematic diagram



Features

- Maximum junction temperature: $T_J = 175\text{ °C}$
- High speed switching series
- Minimized tail current
- $V_{CE(sat)} = 1.6\text{ V (typ.) @ } I_C = 60\text{ A}$
- Tight parameters distribution
- Safe paralleling
- Low thermal resistance

Applications

- Photovoltaic inverters
- High frequency converters

Description

These are IGBT devices developed using an advanced proprietary trench gate and field-stop structure. The devices are part of the new HB series of IGBTs which represent an optimum compromise between conduction and switching loss to maximize the efficiency of any frequency converter. Furthermore, a slightly positive $V_{CE(sat)}$ temperature coefficient and very tight parameter distribution result in safer paralleling operation.

Table 1. Device summary

Order code	Marking	Package	Packing
STGW60H65FB	GW60H65FB	TO-247	Tube
STGWT60H65FB	GWT60H65FB	TO-3P	Tube

Contents

- 1 Electrical ratings 3**
- 2 Electrical characteristics 4**
 - 2.1 Electrical characteristics (curve) 6
- 3 Test circuits 10**
- 4 Package information 11**
 - 4.1 TO-247 package information11
 - 4.2 TO-3P package information 13
- 5 Revision history 15**

1 Electrical ratings

Table 2. Absolute maximum ratings

Symbol	Parameter	Value	Unit
V_{CES}	Collector-emitter voltage ($V_{GE} = 0$)	650	V
I_C	Continuous collector current at $T_C = 25\text{ °C}$	80 ⁽¹⁾	A
	Continuous collector current at $T_C = 100\text{ °C}$	60	
I_{CP} ⁽²⁾	Pulsed collector current	240	A
V_{GE}	Gate-emitter voltage	± 20	V
P_{TOT}	Total dissipation at $T_C = 25\text{ °C}$	375	W
T_{stg}	Storage temperature	-55 to 150	°C
T_j	Operating junction temperature	-55 to 175	

1. Current level is limited by bond wires.
2. Pulse width limited by maximum junction temperature.

Table 3. Thermal data

Symbol	Parameter	Value	Unit
R_{thj-C}	Thermal resistance junction-case	0.4	°C/W
R_{thj-A}	Thermal resistance junction-ambient	50	

2 Electrical characteristics

$T_J = 25\text{ °C}$ unless otherwise specified.

Table 4. Static characteristics

Symbol	Parameter	Test conditions	Min.	Typ.	Max.	Unit
$V_{(BR)CES}$	Collector-emitter breakdown voltage ($V_{GE} = 0$)	$I_C = 2\text{ mA}$	650			V
$V_{CE(sat)}$	Collector-emitter saturation voltage	$V_{GE} = 15\text{ V}, I_C = 60\text{ A}$		1.60	2.0	V
		$V_{GE} = 15\text{ V}, I_C = 60\text{ A}$ $T_J = 125\text{ °C}$		1.75		
		$V_{GE} = 15\text{ V}, I_C = 60\text{ A}$ $T_J = 175\text{ °C}$		1.85		
$V_{GE(th)}$	Gate threshold voltage	$V_{CE} = V_{GE}, I_C = 1\text{ mA}$	5	6	7	V
I_{CES}	Collector cut-off current ($V_{GE} = 0$)	$V_{CE} = 650\text{ V}$			25	μA
I_{GES}	Gate-emitter leakage current ($V_{CE} = 0$)	$V_{GE} = \pm 20\text{ V}$			± 250	nA

Table 5. Dynamic characteristics

Symbol	Parameter	Test conditions	Min.	Typ.	Max.	Unit
C_{ies}	Input capacitance	$V_{CE} = 25\text{ V}, f = 1\text{ MHz},$ $V_{GE} = 0$	-	7792	-	pF
C_{oes}	Output capacitance		-	262	-	
C_{res}	Reverse transfer capacitance		-	158	-	
Q_g	Total gate charge	$V_{CC} = 520\text{ V}, I_C = 60\text{ A},$ $V_{GE} = 15\text{ V},$ see Figure 23	-	306	-	nC
Q_{ge}	Gate-emitter charge		-	126	-	
Q_{gc}	Gate-collector charge		-	58	-	

Table 6. Switching characteristics (inductive load)

Symbol	Parameter	Test conditions	Min.	Typ.	Max.	Unit
$t_{d(on)}$	Turn-on delay time	$V_{CE} = 400\text{ V}$, $I_C = 60\text{ A}$, $R_G = 10\ \Omega$, $V_{GE} = 15\text{ V}$, see Figure 22	-	66		ns
t_r	Current rise time		-	38	-	ns
$(di/dt)_{on}$	Turn-on current slope		-	1216		A/ μ s
$t_{d(off)}$	Turn-off delay time			210		ns
t_f	Current fall time		-	20	-	ns
$E_{on}^{(1)}$	Turn-on switching loss		-	1590	-	μ J
$E_{off}^{(2)}$	Turn-off switching loss		-	900	-	μ J
E_{ts}	Total switching loss	-	2490	-	μ J	
$t_{d(on)}$	Turn-on delay time	$V_{CE} = 400\text{ V}$, $I_C = 60\text{ A}$, $R_G = 10\ \Omega$, $V_{GE} = 15\text{ V}$, $T_J = 175\text{ }^\circ\text{C}$, see Figure 22	-	59		ns
t_r	Current rise time		-	40	-	ns
$(di/dt)_{on}$	Turn-on current slope		-	1230		A/ μ s
$t_{d(off)}$	Turn-off delay time			242		ns
t_f	Current fall time		-	147	-	ns
$E_{on}^{(1)}$	Turn-on switching loss		-	2860	-	μ J
$E_{off}^{(2)}$	Turn-off switching loss		-	1255	-	μ J
E_{ts}	Total switching loss	-	4115	-	μ J	

1. Energy loss includes reverse recovery of the external diode. The diode is the same as the co-packaged STGW60H65DFB.
2. Turn-off loss also includes the tail of the collector current.

2.1 Electrical characteristics (curve)

Figure 2. Output characteristics ($T_J = 25^\circ\text{C}$)

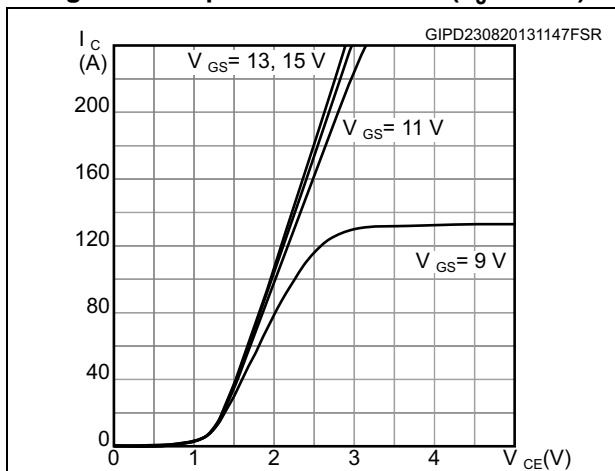

Figure 3. Output characteristics ($T_J = 175^\circ\text{C}$)

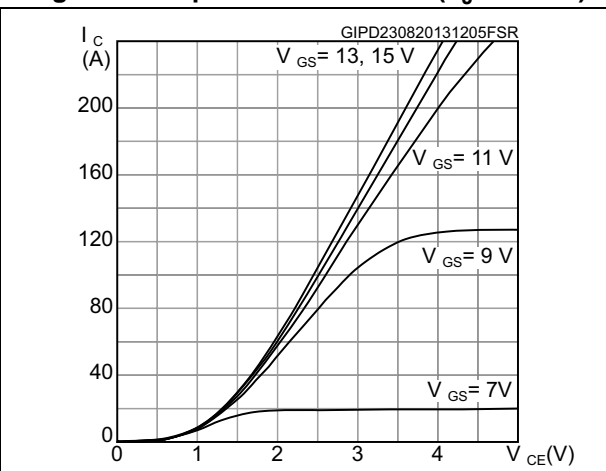

Figure 4. Transfer characteristics

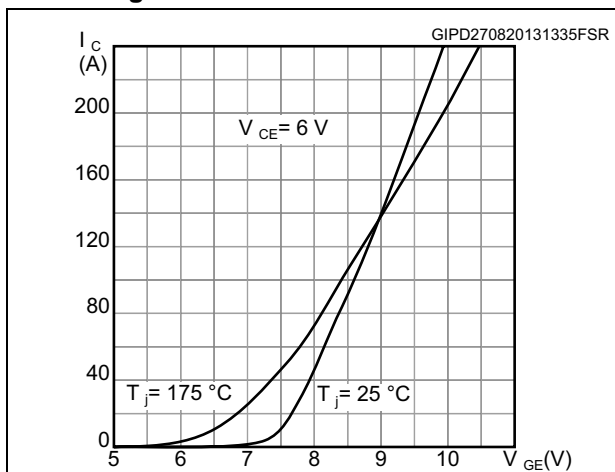

Figure 5. Collector current vs. case temperature

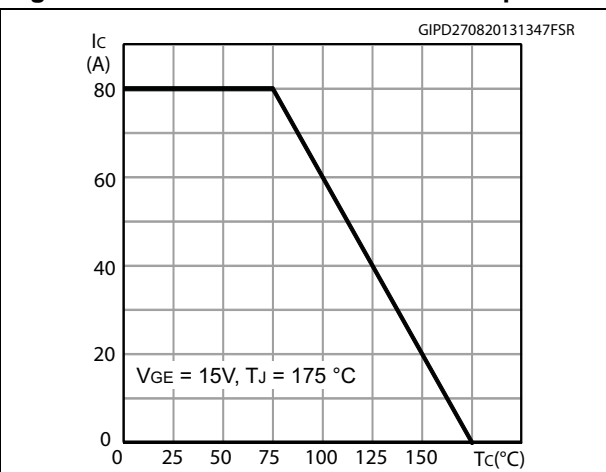

Figure 6. Power dissipation vs. case temperature

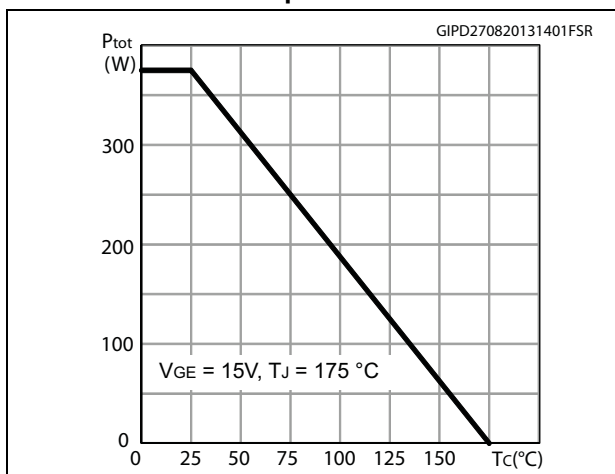

Figure 7. $V_{CE(sat)}$ vs. junction temperature

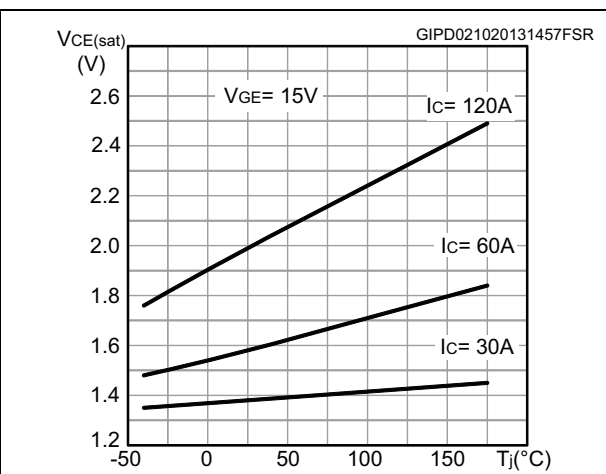

Figure 8. $V_{CE(sat)}$ vs. collector current

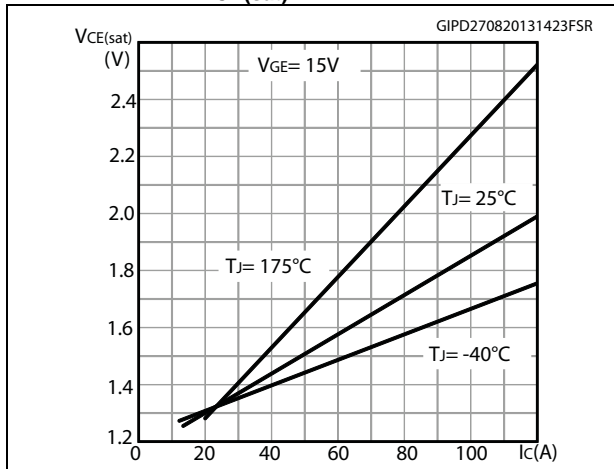

Figure 9. Forward bias safe operating area

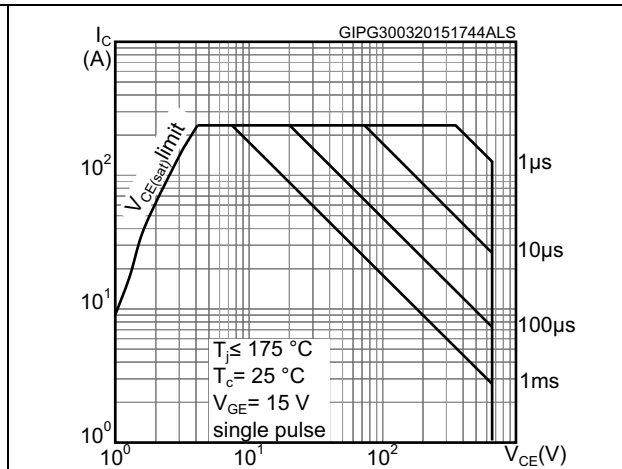

Figure 10. Normalized $V_{(BR)CES}$ vs. junction temperature

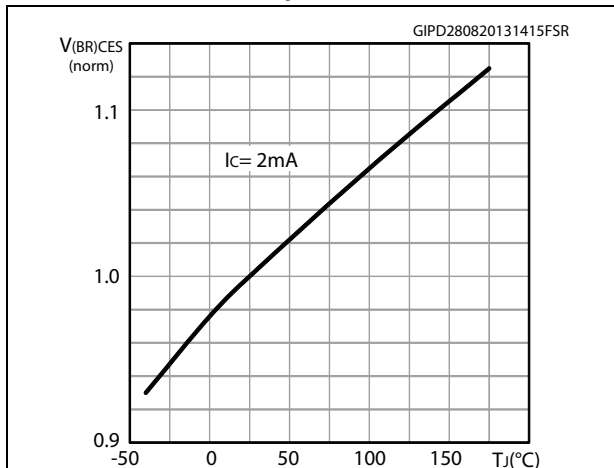

Figure 11. Normalized $V_{GE(th)}$ vs. junction temperature

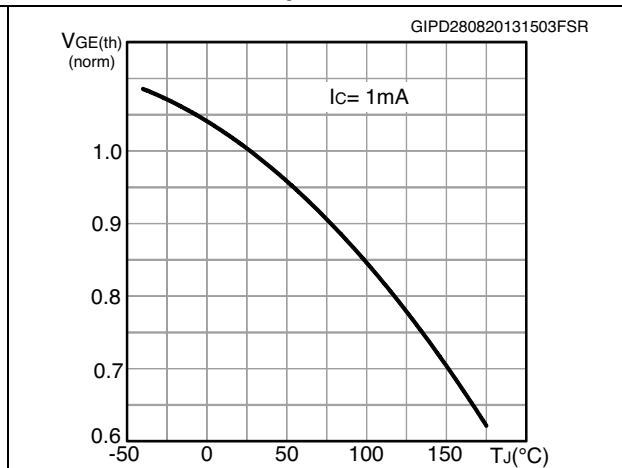

Figure 12. Gate charge vs. gate-emitter voltage

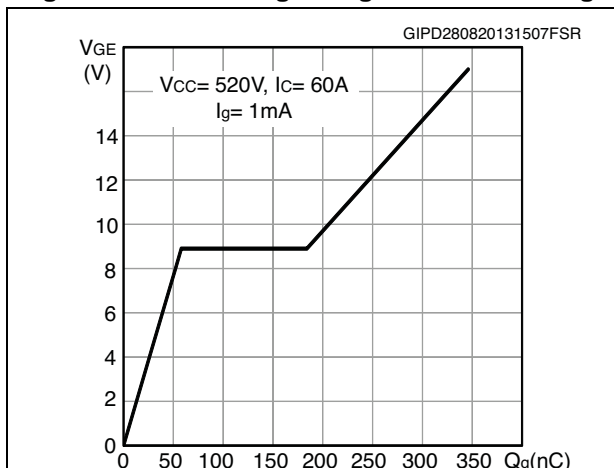

Figure 13. Switching loss vs temperature

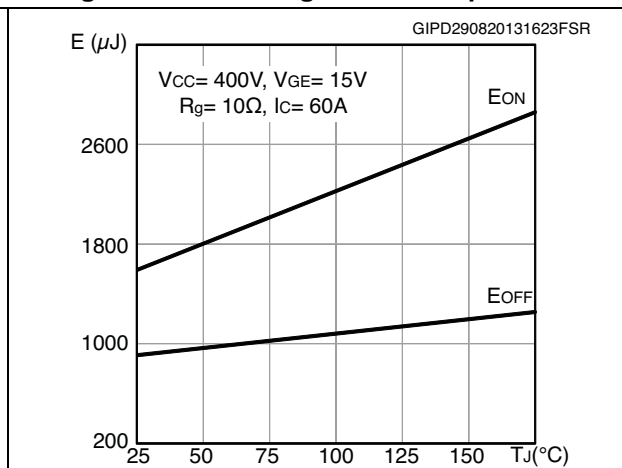

Figure 14. Switching loss vs gate resistance

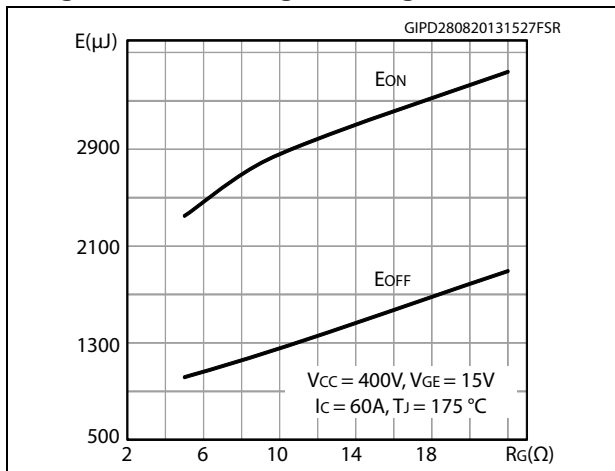

Figure 15. Switching loss vs collector current

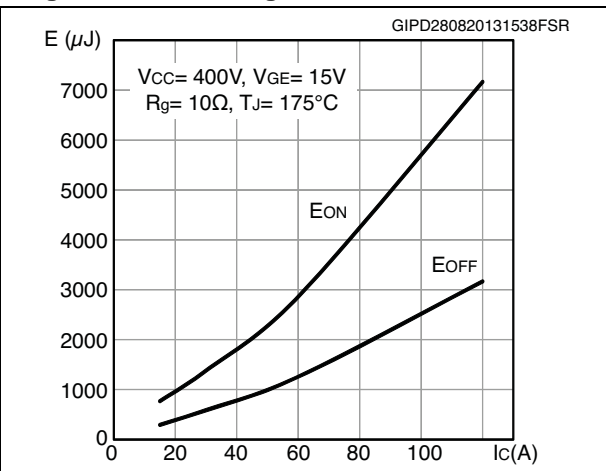

Figure 16. Switching loss vs collector emitter voltage

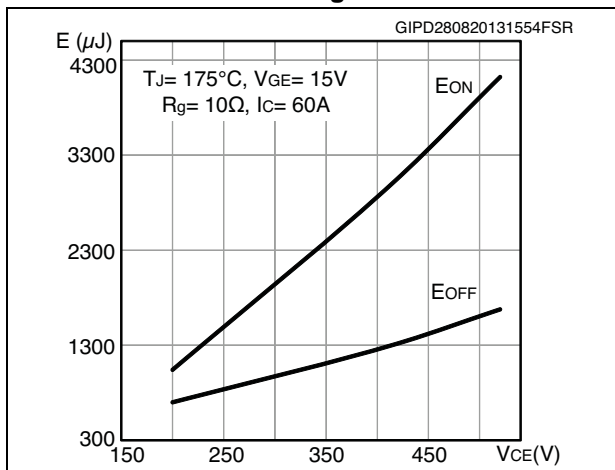

Figure 17. Switching times vs collector current

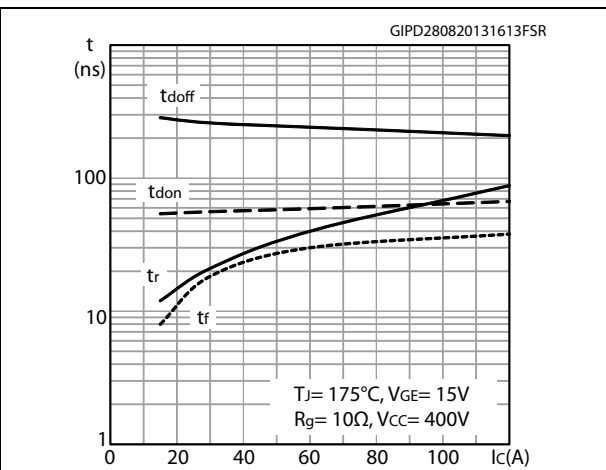

Figure 18. Switching times vs gate resistance

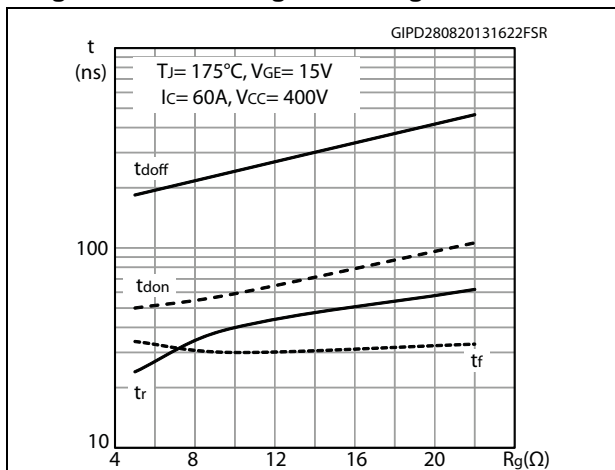

Figure 19. Capacitance variations

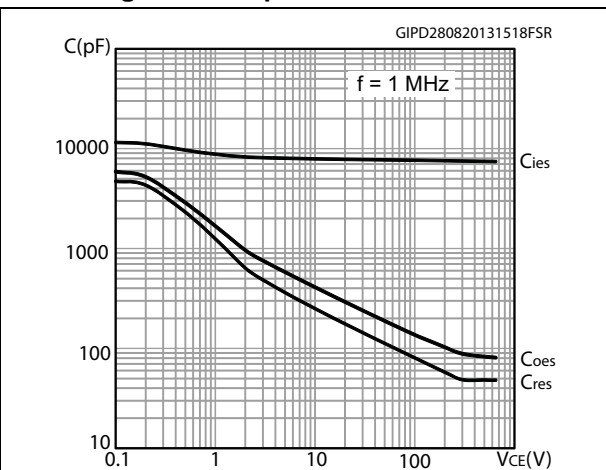

Figure 20. Collector current vs. switching frequency

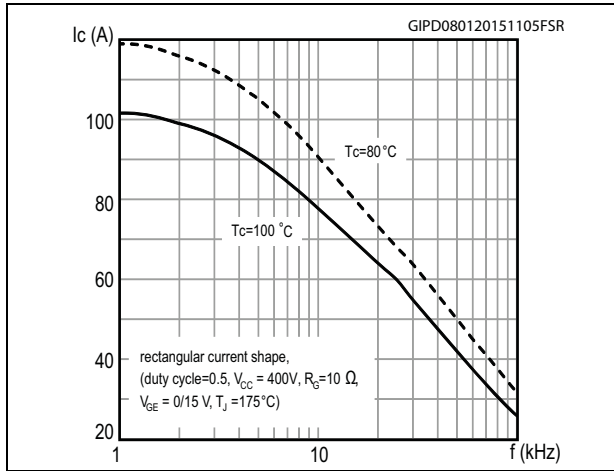
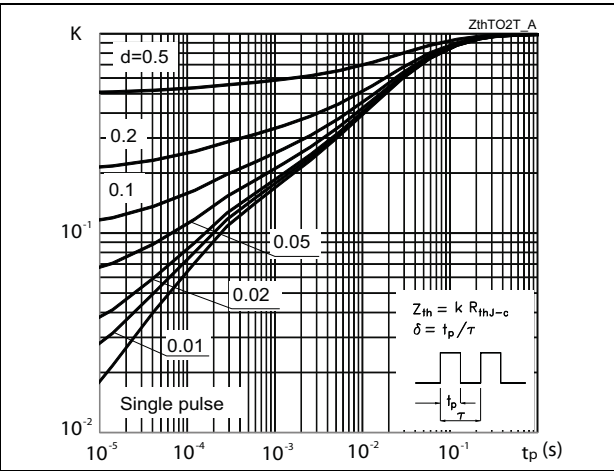

Figure 21. Thermal impedance



4 Package information

In order to meet environmental requirements, ST offers these devices in different grades of ECOPACK® packages, depending on their level of environmental compliance. ECOPACK® specifications, grade definitions and product status are available at: www.st.com. ECOPACK is an ST trademark.

4.1 TO-247 package information

Figure 25. TO-247 package outline

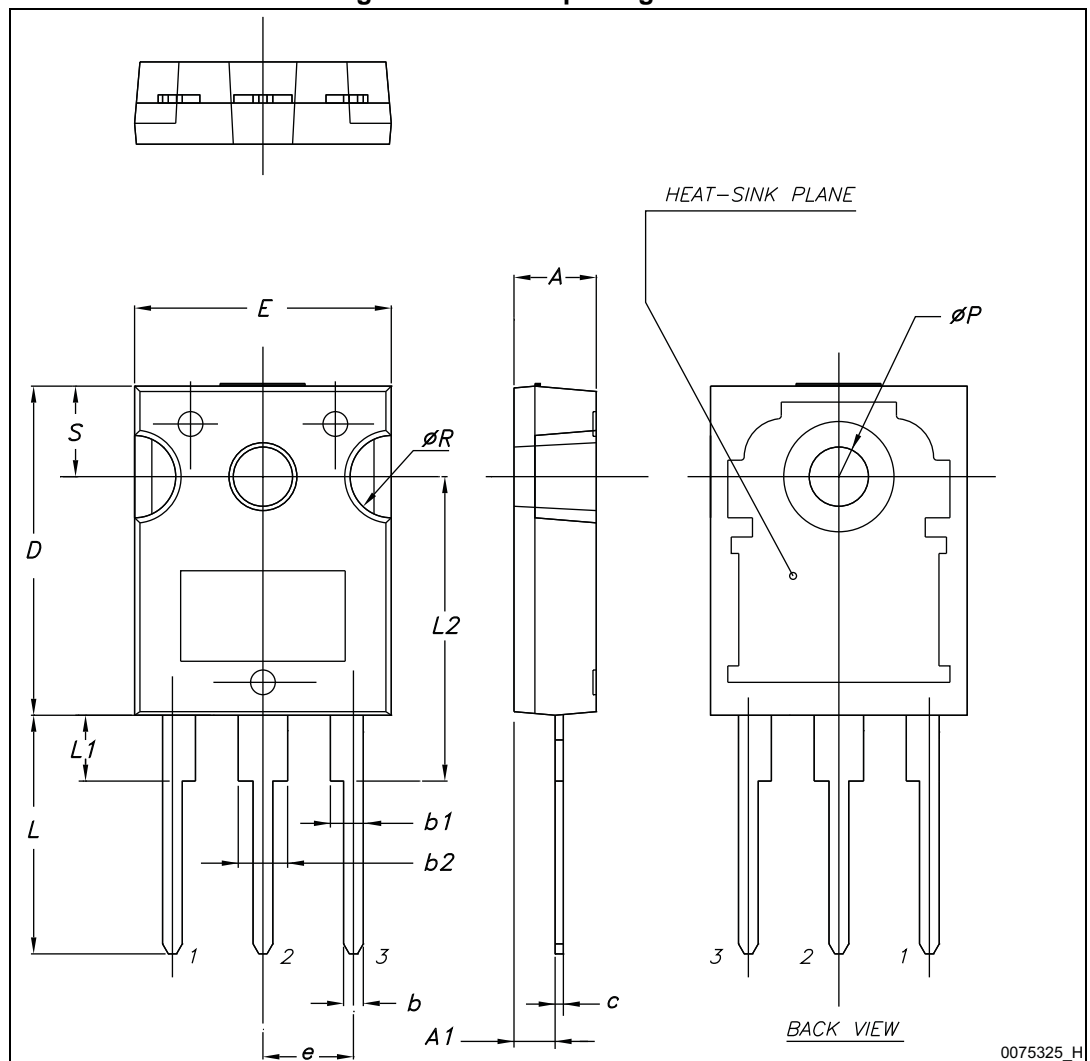

Table 7. TO-247 mechanical data

Dim.	mm.		
	Min.	Typ.	Max.
A	4.85		5.15
A1	2.20		2.60
b	1.0		1.40
b1	2.0		2.40
b2	3.0		3.40
c	0.40		0.80
D	19.85		20.15
E	15.45		15.75
e	5.30	5.45	5.60
L	14.20		14.80
L1	3.70		4.30
L2		18.50	
ØP	3.55		3.65
ØR	4.50		5.50
S	5.30	5.50	5.70

4.2 TO-3P package information

Figure 26. TO-3P package outline

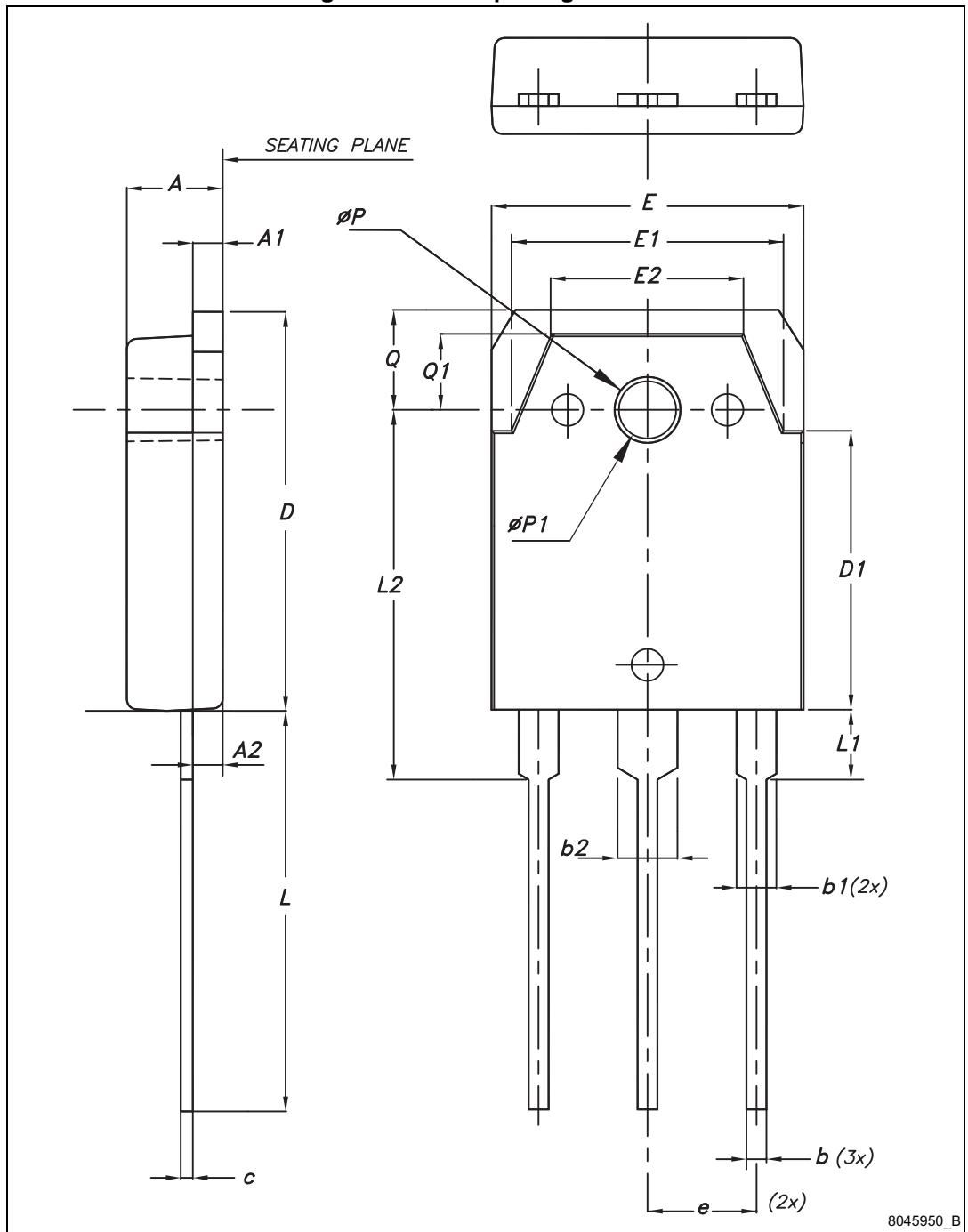

Table 8. TO-3P mechanical data

Dim.	mm		
	Min.	Typ.	Max.
A	4.60	4.80	5
A1	1.45	1.50	1.65
A2	1.20	1.40	1.60
b	0.80	1.00	1.20
b1	1.80	2.00	2.20
b2	2.80	3.00	3.20
c	0.55	0.60	0.75
D	19.70	19.90	20.10
D1	13.70	13.90	14.10
E	15.40	15.60	15.80
E1	13.40	13.60	13.80
E2	9.40	9.60	9.90
e	5.15	5.45	5.75
L	19.80	20	20.20
L1	3.30	3.50	3.70
L2	18.20	18.40	18.60
øP	3.30	3.40	3.50
øP1	3.10	3.20	3.30
Q	4.80	5	5.20
Q1	3.60	3.80	4

5 Revision history

Table 9. Document revision history

Date	Revision	Changes
30-Aug-2013	1	Initial release.
28-Feb-2014	2	Updated title and features in cover page.
09-Jan-2015	3	Updated features in cover page, Table 2: Absolute maximum ratings , Table 4: Static characteristics and Table 6: Switching characteristics (inductive load) . Updated Figure 5: Collector current vs. case temperature , Figure 6: Power dissipation vs. case temperature , Figure 8: $V_{CE(sat)}$ vs. collector current , Figure 17: Switching times vs collector current , Figure 18: Switching times vs gate resistance and Figure 19: Capacitance variations . Added Figure 20: Collector current vs. switching frequency . Updated Section 4: Package information . Minor text changes.
01-Apr-2015	4	Text edits throughout document Updated Table 2: Absolute maximum ratings Updated Table 4: Static characteristics Updated Table 6: Switching characteristics (inductive load) Updated Section 2.1: Electrical characteristics (curve) .

IMPORTANT NOTICE – PLEASE READ CAREFULLY

STMicroelectronics NV and its subsidiaries ("ST") reserve the right to make changes, corrections, enhancements, modifications, and improvements to ST products and/or to this document at any time without notice. Purchasers should obtain the latest relevant information on ST products before placing orders. ST products are sold pursuant to ST's terms and conditions of sale in place at the time of order acknowledgement.

Purchasers are solely responsible for the choice, selection, and use of ST products and ST assumes no liability for application assistance or the design of Purchasers' products.

No license, express or implied, to any intellectual property right is granted by ST herein.

Resale of ST products with provisions different from the information set forth herein shall void any warranty granted by ST for such product.

ST and the ST logo are trademarks of ST. All other product or service names are the property of their respective owners.

Information in this document supersedes and replaces information previously supplied in any prior versions of this document.

© 2015 STMicroelectronics – All rights reserved

Mouser Electronics

Authorized Distributor

Click to View Pricing, Inventory, Delivery & Lifecycle Information:

[STMicroelectronics:](#)

[STGW60H65FB](#) [STGWT60H65FB](#)