



STI260N6F6 STP260N6F6

N-channel 60 V, 0.0024 Ω , 120 A STripFET™ VI DeepGATE™
Power MOSFET in TO-220 and I²PAK packages

Features

| Order codes | V _{DSS} | R _{DS(on)} max | I _D |
|--------------------------|------------------|-------------------------|----------------|
| STI260N6F6 STP260N6F6 | 60 V | < 0.003 Ω | 120 A |

- Low gate charge
- Very low on-resistance
- High avalanche ruggedness

Application

- Switching applications

Description

These devices are N-channel Power MOSFETs developed using the 6th generation of STripFET™ DeepGATE™ technology, with a new gate structure. The resulting Power MOSFETs exhibits the lowest R_{DS(on)} in all packages.

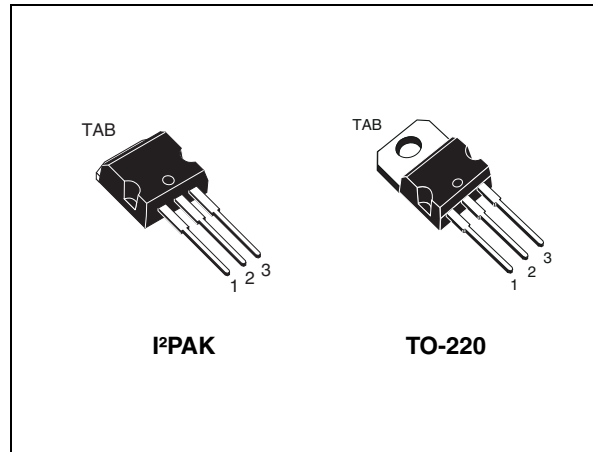

Figure 1. Internal schematic diagram

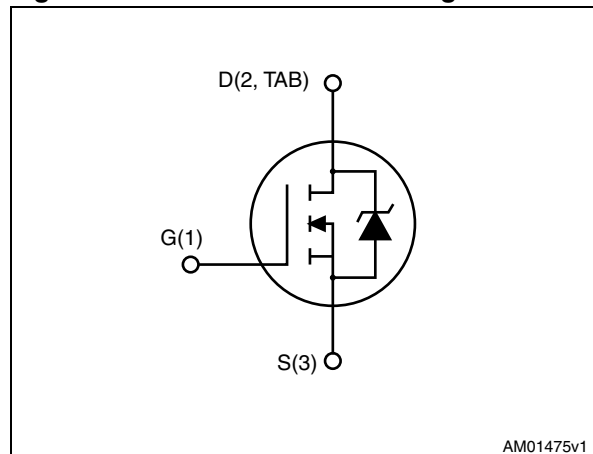

Table 1. Device summary

| Order codes | Marking | Package | Packaging |
|-------------|---------|--------------------|-----------|
| STI260N6F6 | 260N6F6 | I ² PAK | Tube |
| STP260N6F6 | | TO-220 | |

Contents

| | | |
|----------|---|-----------|
| 1 | Electrical ratings | 3 |
| 2 | Electrical characteristics | 4 |
| | 2.1 Electrical characteristics (curves) | 6 |
| 3 | Test circuits | 8 |
| 4 | Package mechanical data | 9 |
| 5 | Revision history | 13 |

1 Electrical ratings

Table 2. Absolute maximum ratings

| Symbol | Parameter | Value | Unit |
|----------------|---|-------------|---------------------|
| V_{DS} | Drain-source voltage | 60 | V |
| V_{GS} | Gate-source voltage | ± 20 | V |
| I_D | Drain current (continuous) at $T_C = 25\text{ }^\circ\text{C}$ | 120 | A |
| I_D | Drain current (continuous) at $T_C = 100\text{ }^\circ\text{C}$ | 120 | A |
| $I_{DM}^{(1)}$ | Drain current (pulsed) | 480 | A |
| P_{TOT} | Total dissipation at $T_C = 25\text{ }^\circ\text{C}$ | 300 | W |
| | Derating factor | 2 | W/ $^\circ\text{C}$ |
| T_{stg} | Storage temperature | - 55 to 175 | $^\circ\text{C}$ |
| T_j | Operating junction temperature | | |

1. Current limited by package.

Table 3. Thermal data

| Symbol | Parameter | Value | Unit |
|----------------|--|-------|---------------------------|
| $R_{thj-case}$ | Thermal resistance junction-case max | 0.5 | $^\circ\text{C}/\text{W}$ |
| R_{thj-a} | Thermal resistance junction-ambient max | 62.5 | $^\circ\text{C}/\text{W}$ |
| T_l | Maximum lead temperature for soldering purpose | 300 | $^\circ\text{C}$ |

2 Electrical characteristics

($T_{CASE} = 25\text{ °C}$ unless otherwise specified)

Table 4. On/off states

| Symbol | Parameter | Test conditions | Min. | Typ. | Max. | Unit |
|---------------|--|---|------|------|-----------|--------------------|
| $V_{(BR)DSS}$ | Drain-source breakdown voltage ($V_{GS} = 0$) | $I_D = 250\ \mu A$ | 60 | | | V |
| I_{DSS} | Zero gate voltage Drain current ($V_{GS} = 0$) | $V_{DS} = 60\text{ V}$ $V_{DS} = 60\text{ V}, T_C = 125\text{ °C}$ | | | 1 100 | μA μA |
| I_{GSS} | Gate-body leakage current ($V_{DS} = 0$) | $V_{GS} = \pm 20\text{ V}$ | | | ± 100 | nA |
| $V_{GS(th)}$ | Gate threshold voltage | $V_{DS} = V_{GS}, I_D = 250\ \mu A$ | 2 | | 4 | V |
| $R_{DS(on)}$ | Static drain-source on-resistance | $V_{GS} = 10\text{ V}, I_D = 60\text{ A}$ | | 2.4 | 3 | m Ω |

Table 5. Dynamic

| Symbol | Parameter | Test conditions | Min. | Typ. | Max. | Unit |
|-----------|------------------------------|---|------|-------|------|------|
| C_{iss} | Input capacitance | | | 11400 | | pF |
| C_{oss} | Output capacitance | $V_{DS} = 25\text{ V}, f = 1\text{ MHz},$ $V_{GS} = 0$ | - | 850 | - | pF |
| C_{rss} | Reverse transfer capacitance | | | 368 | | pF |
| Q_g | Total gate charge | $V_{DD} = 30\text{ V}, I_D = 120\text{ A},$ $V_{GS} = 10\text{ V}$ <i>(see Figure 14)</i> | | 183 | | nC |
| Q_{gs} | Gate-source charge | | - | 53 | - | nC |
| Q_{gd} | Gate-drain charge | | | 41 | | nC |

Table 6. Switching times

| Symbol | Parameter | Test conditions | Min. | Typ. | Max. | Unit |
|--------------|---------------------|--|------|-------|------|------|
| $t_{d(on)}$ | Turn-on delay time | $V_{DD} = 30\text{ V}, I_D = 60\text{ A}$ $R_G = 4.7\ \Omega, V_{GS} = 10\text{ V}$ <i>(see Figure 13)</i> | - | 31.4 | - | ns |
| t_r | Rise time | | - | 165 | - | ns |
| $t_{d(off)}$ | Turn-off-delay time | $V_{DD} = 30\text{ V}, I_D = 60\text{ A}$ $R_G = 4.7\ \Omega, V_{GS} = 10\text{ V}$ <i>(see Figure 13)</i> | - | 144.4 | - | ns |
| t_f | Fall time | | - | 62.6 | - | ns |

Table 7. Source drain diode

| Symbol | Parameter | Test conditions | Min. | Typ. | Max | Unit |
|-----------------|-------------------------------|--|------|------|-----|------|
| I_{SD} | Source-drain current | | - | | 120 | A |
| $I_{SDM}^{(1)}$ | Source-drain current (pulsed) | | - | | 480 | A |
| $V_{SD}^{(2)}$ | Forward on voltage | $I_{SD} = 120 \text{ A}, V_{GS} = 0$ | - | | 1.1 | V |
| t_{rr} | Reverse recovery time | $I_{SD} = 120 \text{ A}, V_{DD} = 48 \text{ V}$ $di/dt = 100 \text{ A}/\mu\text{s}$, $T_j = 150 \text{ }^\circ\text{C}$ <i>(see Figure 15)</i> | - | 55.6 | | ns |
| Q_{rr} | Reverse recovery charge | | | 116 | | nC |
| I_{RRM} | Reverse recovery current | | | 3.8 | | A |

1. Current limited by package.
2. Pulsed: pulse duration = 300 μs , duty cycle 1.5%

2.1 Electrical characteristics (curves)

Figure 2. Safe operating area

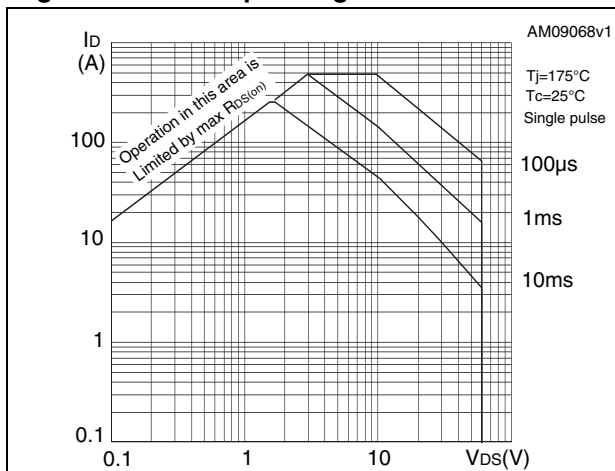

Figure 3. Thermal impedance

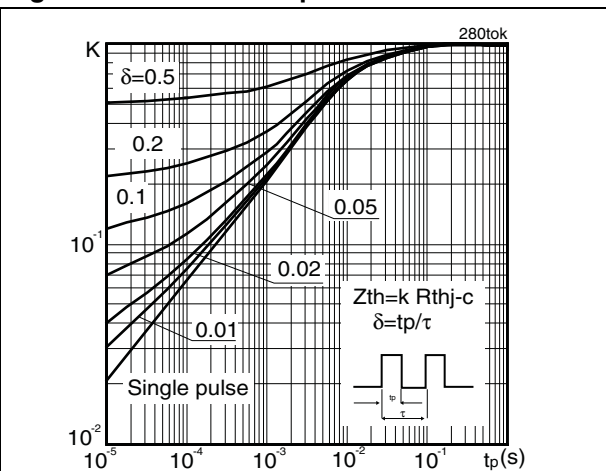

Figure 4. Output characteristics

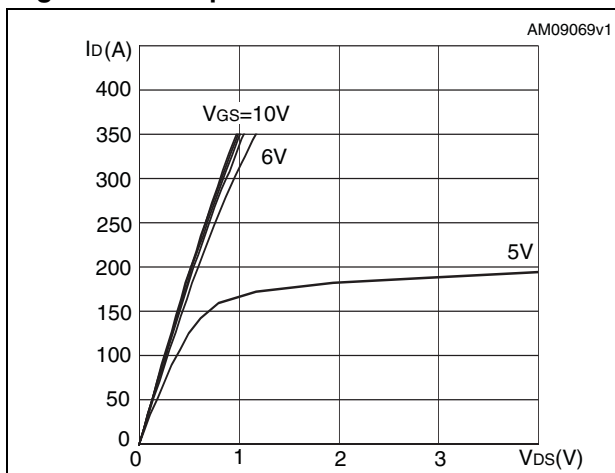

Figure 5. Transfer characteristics

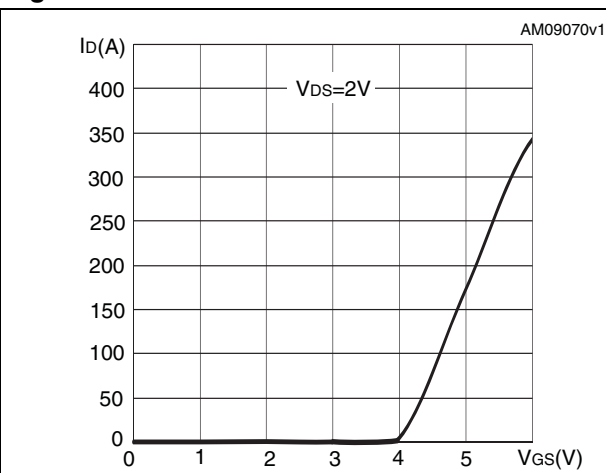

Figure 6. Normalized $B_{V_{DSS}}$ vs. temperature

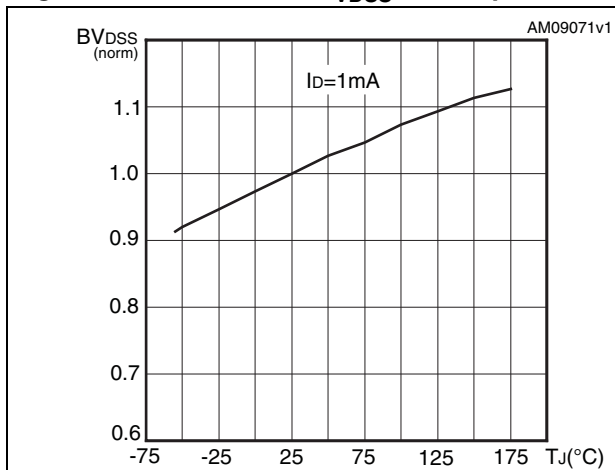

Figure 7. Static drain-source on resistance

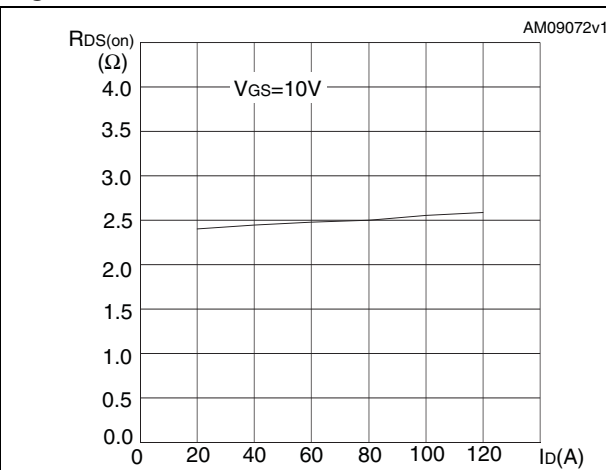

Figure 8. Gate charge vs. gate-source voltage

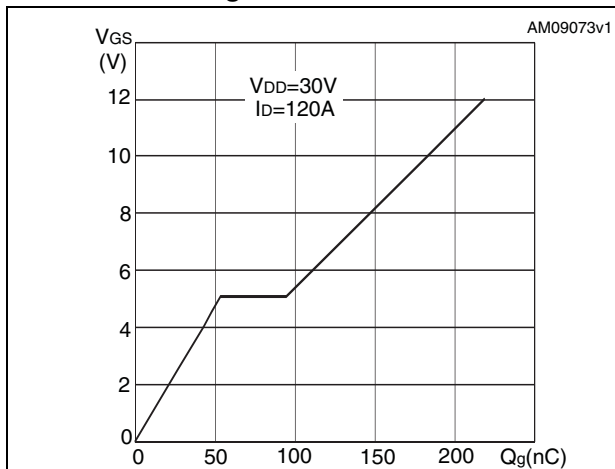

Figure 9. Capacitance variations

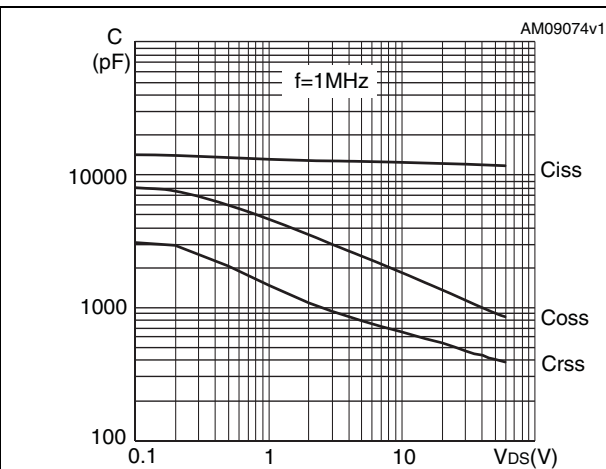

Figure 10. Normalized gate threshold voltage vs. temperature

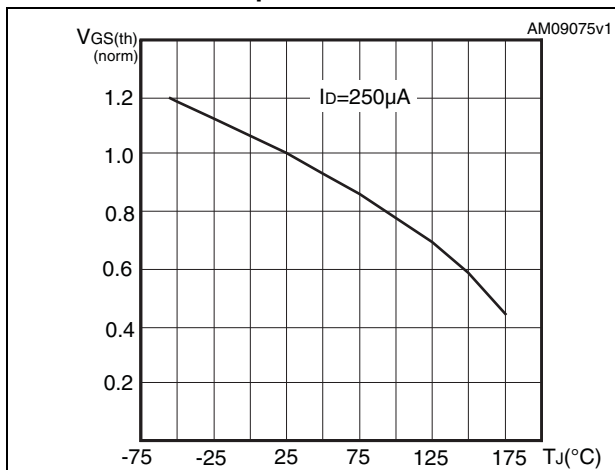

Figure 11. Normalized on resistance vs. temperature

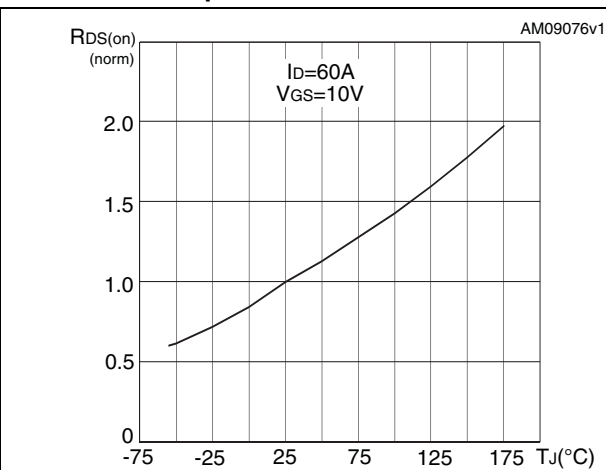
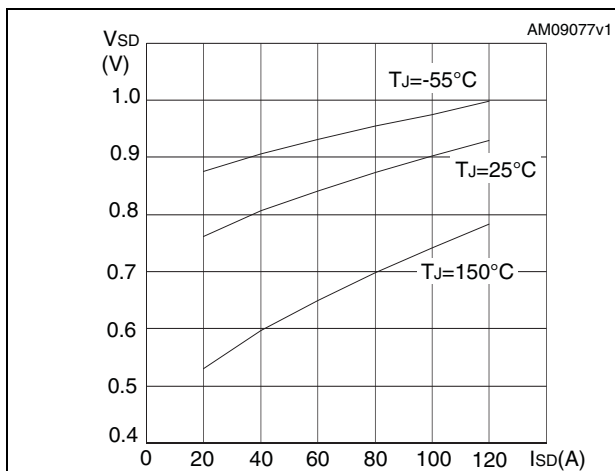

Figure 12. Source-drain diode forward characteristics



3 Test circuits

Figure 13. Switching times test circuit for resistive load



AM01468v1

Figure 14. Gate charge test circuit



AM01469v1

Figure 15. Test circuit for inductive load switching and diode recovery times



AM01470v1

Figure 16. Unclamped inductive load test circuit



AM01471v1

Figure 17. Unclamped inductive waveform

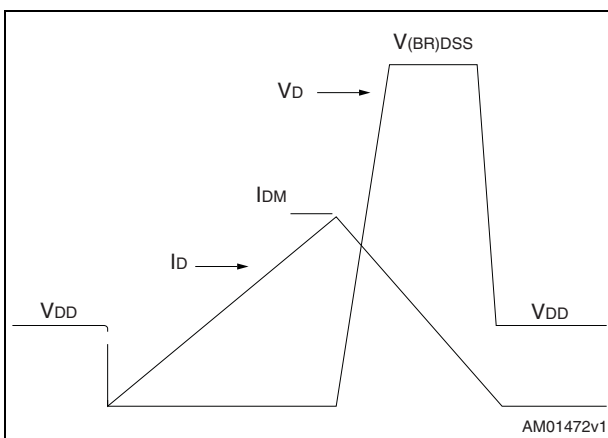

AM01472v1

Figure 18. Switching time waveform

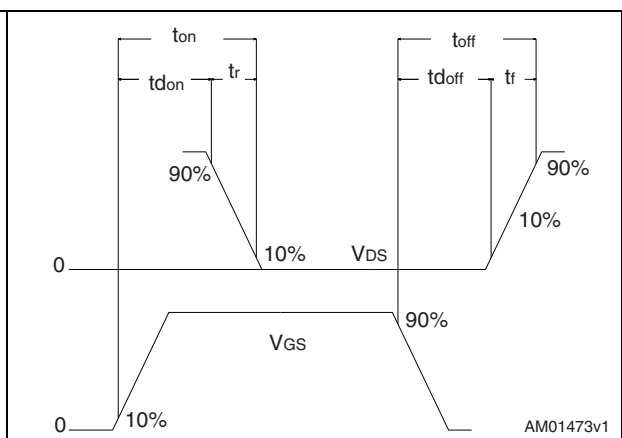

AM01473v1

4 Package mechanical data

In order to meet environmental requirements, ST offers these devices in different grades of ECOPACK[®] packages, depending on their level of environmental compliance. ECOPACK[®] specifications, grade definitions and product status are available at: www.st.com. ECOPACK is an ST trademark.

Table 8. I²PAK (TO-262) mechanical data

| DIM. | mm. | | |
|------|------|-----|-------|
| | min. | typ | max. |
| A | 4.40 | | 4.60 |
| A1 | 2.40 | | 2.72 |
| b | 0.61 | | 0.88 |
| b1 | 1.14 | | 1.70 |
| c | 0.49 | | 0.70 |
| c2 | 1.23 | | 1.32 |
| D | 8.95 | | 9.35 |
| e | 2.40 | | 2.70 |
| e1 | 4.95 | | 5.15 |
| E | 10 | | 10.40 |
| L | 13 | | 14 |
| L1 | 3.50 | | 3.93 |
| L2 | 1.27 | | 1.40 |

Figure 19. I²PAK (TO-262) drawing

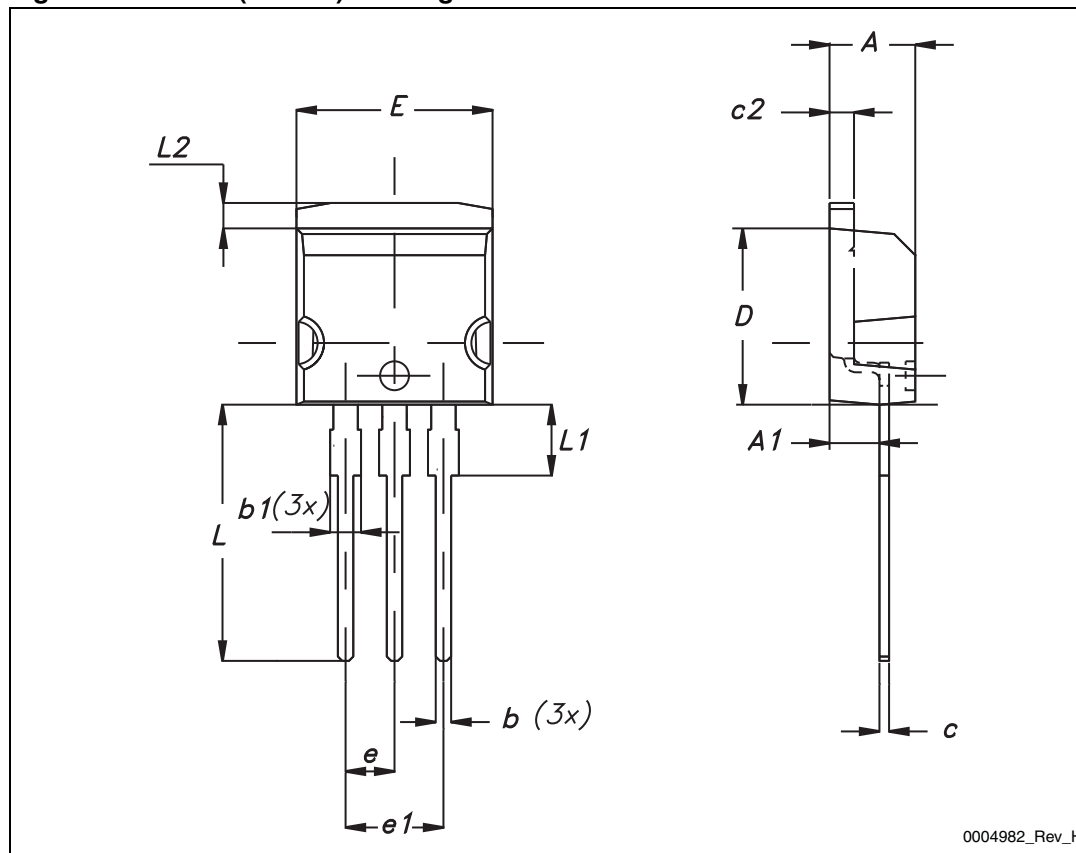

0004982_Rev_H

Table 9. TO-220 type A mechanical data

| Dim. | mm | | |
|------|-------|-------|-------|
| | Min. | Typ. | Max. |
| A | 4.40 | | 4.60 |
| b | 0.61 | | 0.88 |
| b1 | 1.14 | | 1.70 |
| c | 0.48 | | 0.70 |
| D | 15.25 | | 15.75 |
| D1 | | 1.27 | |
| E | 10 | | 10.40 |
| e | 2.40 | | 2.70 |
| e1 | 4.95 | | 5.15 |
| F | 1.23 | | 1.32 |
| H1 | 6.20 | | 6.60 |
| J1 | 2.40 | | 2.72 |
| L | 13 | | 14 |
| L1 | 3.50 | | 3.93 |
| L20 | | 16.40 | |
| L30 | | 28.90 | |
| ØP | 3.75 | | 3.85 |
| Q | 2.65 | | 2.95 |

Figure 20. TO-220 type A drawing

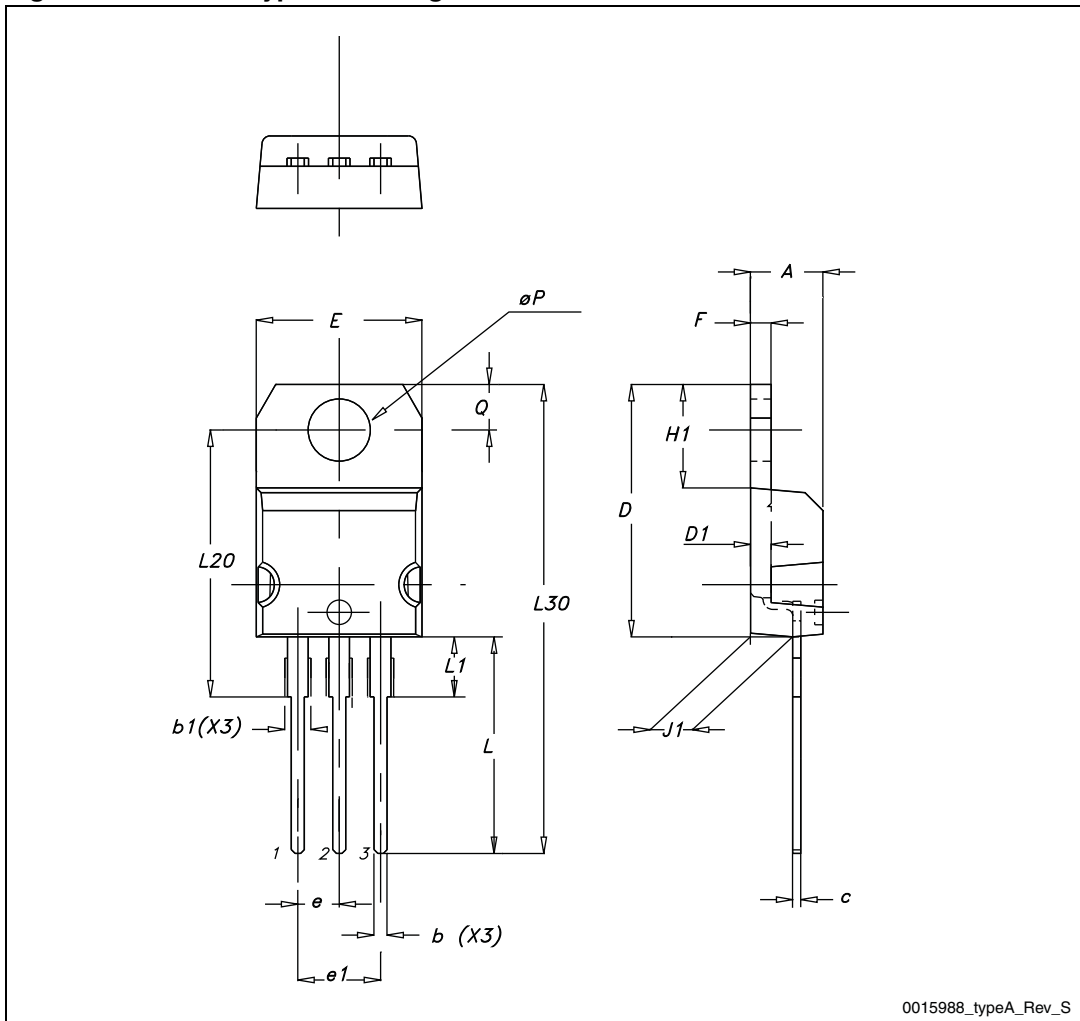

0015988_typeA_Rev_S

5 Revision history

Table 10. Document revision history

| Date | Revision | Changes |
|-------------|----------|---|
| 07-May-2010 | 1 | First release. |
| 18-Apr-2011 | 2 | Document status promoted from preliminary data to datasheet. |
| 27-Apr-2011 | 3 | <i>Device summary</i> has been updated. |
| 05-Oct-2011 | 4 | <i>Table 2: Absolute maximum ratings</i> has been updated. Minor text changes. |
| 13-Jan-2012 | 5 | Updated <i>Table 2: Absolute maximum ratings</i> . |

Please Read Carefully:

Information in this document is provided solely in connection with ST products. STMicroelectronics NV and its subsidiaries ("ST") reserve the right to make changes, corrections, modifications or improvements, to this document, and the products and services described herein at any time, without notice.

All ST products are sold pursuant to ST's terms and conditions of sale.

Purchasers are solely responsible for the choice, selection and use of the ST products and services described herein, and ST assumes no liability whatsoever relating to the choice, selection or use of the ST products and services described herein.

No license, express or implied, by estoppel or otherwise, to any intellectual property rights is granted under this document. If any part of this document refers to any third party products or services it shall not be deemed a license grant by ST for the use of such third party products or services, or any intellectual property contained therein or considered as a warranty covering the use in any manner whatsoever of such third party products or services or any intellectual property contained therein.

UNLESS OTHERWISE SET FORTH IN ST'S TERMS AND CONDITIONS OF SALE ST DISCLAIMS ANY EXPRESS OR IMPLIED WARRANTY WITH RESPECT TO THE USE AND/OR SALE OF ST PRODUCTS INCLUDING WITHOUT LIMITATION IMPLIED WARRANTIES OF MERCHANTABILITY, FITNESS FOR A PARTICULAR PURPOSE (AND THEIR EQUIVALENTS UNDER THE LAWS OF ANY JURISDICTION), OR INFRINGEMENT OF ANY PATENT, COPYRIGHT OR OTHER INTELLECTUAL PROPERTY RIGHT.

UNLESS EXPRESSLY APPROVED IN WRITING BY TWO AUTHORIZED ST REPRESENTATIVES, ST PRODUCTS ARE NOT RECOMMENDED, AUTHORIZED OR WARRANTED FOR USE IN MILITARY, AIR CRAFT, SPACE, LIFE SAVING, OR LIFE SUSTAINING APPLICATIONS, NOR IN PRODUCTS OR SYSTEMS WHERE FAILURE OR MALFUNCTION MAY RESULT IN PERSONAL INJURY, DEATH, OR SEVERE PROPERTY OR ENVIRONMENTAL DAMAGE. ST PRODUCTS WHICH ARE NOT SPECIFIED AS "AUTOMOTIVE GRADE" MAY ONLY BE USED IN AUTOMOTIVE APPLICATIONS AT USER'S OWN RISK.

Resale of ST products with provisions different from the statements and/or technical features set forth in this document shall immediately void any warranty granted by ST for the ST product or service described herein and shall not create or extend in any manner whatsoever, any liability of ST.

ST and the ST logo are trademarks or registered trademarks of ST in various countries.

Information in this document supersedes and replaces all information previously supplied.

The ST logo is a registered trademark of STMicroelectronics. All other names are the property of their respective owners.

© 2012 STMicroelectronics - All rights reserved

STMicroelectronics group of companies

Australia - Belgium - Brazil - Canada - China - Czech Republic - Finland - France - Germany - Hong Kong - India - Israel - Italy - Japan - Malaysia - Malta - Morocco - Philippines - Singapore - Spain - Sweden - Switzerland - United Kingdom - United States of America

www.st.com

Mouser Electronics

Authorized Distributor

Click to View Pricing, Inventory, Delivery & Lifecycle Information:

[STMicroelectronics:](#)

[STP260N6F6](#)