

N-channel 450 V - 3.3 Ω typ., 0.6 A Zener-protected, SuperMESH3™ Power MOSFET in a TO-92 package

Datasheet - production data

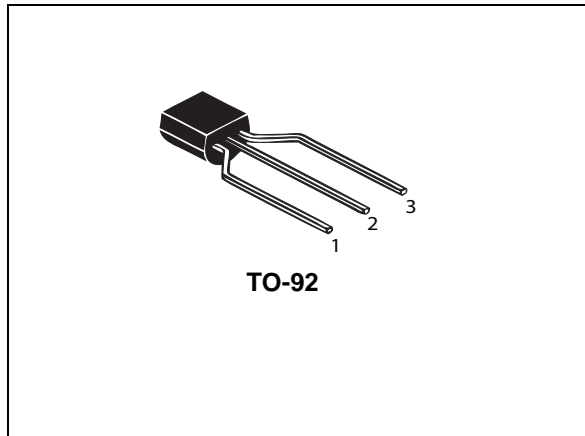
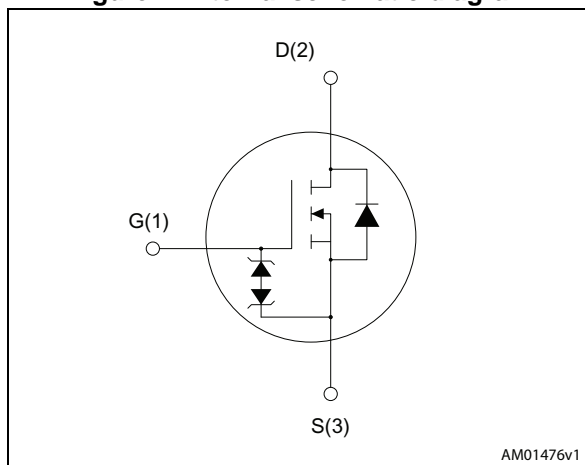

Figure 1. Internal schematic diagram



Features

Order code	V _{DSS}	R _{DS(on) max}	I _D	P _w
STQ3N45K3-AP	450 V	< 4 Ω	0.6 A	3 W

- 100% avalanche tested
- Extremely high dv/dt capability
- Gate charge minimized
- Very low intrinsic capacitance
- Improved diode reverse recovery characteristics
- Zener-protected

Applications

- Switching applications

Description

This SuperMESH3™ Power MOSFET is the result of improvements applied to STMicroelectronics' SuperMESH™ technology, combined with a new optimized vertical structure. This device boasts an extremely low on-resistance, superior dynamic performance and high avalanche capability, rendering it suitable for the most demanding applications.

Table 1. Device summary

Order code	Marking	Package	Packaging
STQ3N45K3-AP	3N45K3	TO-92	Ammopak

Contents

1	Electrical ratings	3
2	Electrical characteristics	4
2.1	Electrical characteristics (curves)	6
3	Test circuits	9
4	Package mechanical data	10
5	Revision history	13

1 Electrical ratings

Table 2. Absolute maximum ratings

Symbol	Parameter	Value	Unit
V_{DS}	Drain-source voltage ($V_{GS} = 0$)	450	V
V_{GS}	Gate- source voltage	± 30	V
I_D	Drain current (continuous) at $T_C = 25\text{ }^\circ\text{C}$	0.6	A
$I_{DM}^{(1)}$	Drain current (pulsed)	2.4	A
P_{TOT}	Total dissipation at $T_C = 25\text{ }^\circ\text{C}$	3	W
$I_{AR}^{(2)}$	Avalanche current, repetitive or not-repetitive	0.6	A
$E_{AS}^{(3)}$	Single pulse avalanche energy (starting $T_j = 25\text{ }^\circ\text{C}$, $I_D = I_{AR}$, $V_{DD} = 50\text{V}$)	45	mJ
$dv/dt^{(4)}$	Peak diode recovery voltage slope	12	V/ns
Vesd(g-s)	G-S ESD (HBM C = 100 pF, R = 1.5 k Ω)	1000	V
T_{stg}	Storage temperature	-55 to 150	$^\circ\text{C}$
T_j	Max. operating junction temperature	150	$^\circ\text{C}$

1. Pulse width limited by safe operating area.
2. Pulse width limited by $T_{j\text{ max}}$.
3. Starting $T_j = 25\text{ }^\circ\text{C}$, $I_D = I_{AR}$, $V_{DD} = 50\text{ V}$.
4. $I_{SD} \leq 0.6\text{ A}$, $di/dt \leq 400\text{ A}/\mu\text{s}$, $V_{DS\text{ peak}} \leq V_{(BR)DSS}$, $V_{DD} = 80\% V_{(BR)DSS}$.

Table 3. Thermal data

Symbol	Parameter	Value	Unit
$R_{thj\text{-case}}$	Thermal resistance junction-ambient	42	$^\circ\text{C}/\text{W}$

2 Electrical characteristics

($T_C = 25\text{ °C}$ unless otherwise specified)

Table 4. On /off states

Symbol	Parameter	Test conditions	Min.	Typ.	Max.	Unit
$V_{(BR)DSS}$	Drain-source breakdown voltage	$I_D = 1\text{ mA}$, $V_{GS} = 0$	450			V
I_{DSS}	Zero gate voltage drain current ($V_{GS} = 0$)	$V_{DS} = 450\text{ V}$ $V_{DS} = 450\text{ V}$, $T_C = 125\text{ °C}$			1 50	μA μA
I_{GSS}	Gate-body leakage current ($V_{DS} = 0$)	$V_{GS} = \pm 20\text{ V}$			± 10	μA
$V_{GS(th)}$	Gate threshold voltage	$V_{DS} = V_{GS}$, $I_D = 50\text{ }\mu\text{A}$	3	3.75	4.5	V
$R_{DS(on)}$	Static drain-source on resistance	$V_{GS} = 10\text{ V}$, $I_D = 0.6\text{ A}$		3.3	4	Ω

Table 5. Dynamic

Symbol	Parameter	Test conditions	Min.	Typ.	Max.	Unit
C_{iss}	Input capacitance	$V_{DS} = 50\text{ V}$, $f = 1\text{ MHz}$, $V_{GS} = 0$	-	164	-	pF
C_{oss}	Output capacitance		-	17	-	pF
C_{riss}	Reverse transfer capacitance		-	3	-	pF
$C_{o(tr)}^{(1)}$	Equivalent capacitance time related	$V_{DS} = 0\text{ to }360\text{ V}$, $V_{GS} = 0$	-	13	-	pF
$C_{o(er)}^{(2)}$	Equivalent capacitance energy related		-	18	-	pF
R_G	Intrinsic gate resistance	$f = 1\text{ MHz}$ open drain	-	8	-	Ω
Q_g	Total gate charge	$V_{DD} = 360\text{ V}$, $I_D = 1.8\text{ A}$, $V_{GS} = 10\text{ V}$ (see Figure 16)	-	9.5	-	nC
Q_{gs}	Gate-source charge		-	2	-	nC
Q_{gd}	Gate-drain charge		-	6	-	nC

- $C_{oss\text{ eq}}$ time related is defined as a constant equivalent capacitance giving the same charging time as C_{oss} when V_{DS} increases from 0 to 80% V_{DSS}
- $C_{oss\text{ eq}}$ energy related is defined as a constant equivalent capacitance giving the same charging time as C_{oss} when V_{DS} increases from 0 to 80% V_{DSS}

Table 6. Switching times

Symbol	Parameter	Test conditions	Min.	Typ.	Max	Unit
$t_{d(on)}$	Turn-on delay time	$V_{DD} = 225\text{ V}$, $I_D = 0.9\text{ A}$, $R_G = 4.7\ \Omega$, $V_{GS} = 10\text{ V}$ (see Figure 15)	-	6.5	-	ns
t_r	Rise time		-	5.4	-	ns
$t_{d(off)}$	Turn-off-delay time		-	17	-	ns
t_f	Fall time		-	22	-	ns

Table 7. Source drain diode

Symbol	Parameter	Test conditions	Min.	Typ.	Max.	Unit
I_{SD}	Source-drain current		-		0.6	A
$I_{SDM}^{(1)}$	Source-drain current (pulsed)		-		2.4	A
$V_{SD}^{(2)}$	Forward on voltage	$I_{SD} = 0.6\text{ A}$, $V_{GS} = 0$	-		1.5	V
t_{rr}	Reverse recovery time	$I_{SD} = 1.8\text{ A}$, $di/dt = 100\text{ A}/\mu\text{s}$ $V_{DD} = 60\text{ V}$ (see Figure 20)	-	175		ns
Q_{rr}	Reverse recovery charge		-	550		nC
I_{RRM}	Reverse recovery current		-	6		A
t_{rr}	Reverse recovery time	$I_{SD} = 1.8\text{ A}$, $di/dt = 100\text{ A}/\mu\text{s}$ $V_{DD} = 60\text{ V}$, $T_j = 150\text{ }^\circ\text{C}$ (see Figure 20)	-	185		ns
Q_{rr}	Reverse recovery charge		-	600		nC
I_{RRM}	Reverse recovery current		-	6.5		A

1. Pulse width limited by safe operating area.

2. Pulsed: Pulse duration = 300 μs , duty cycle 1.5%.

Table 8. Gate-source Zener diode

Symbol	Parameter	Test conditions	Min	Typ	Max	Unit
$V_{(BR)GSO}$	Gate-source breakdown voltage	$I_{GS} = \pm 1\text{ mA}$, $I_D = 0$	30	-	-	V

The built-in back-to-back Zener diodes have been specifically designed to enhance not only the device's ESD capability, but also to make them capable of safely absorbing any voltage transients that may occasionally be applied from gate to source. In this respect, the Zener voltage is appropriate to achieve efficient and cost-effective protection of device integrity. The integrated Zener diodes thus eliminate the need for external components.

2.1 Electrical characteristics (curves)

Figure 2. Safe operating area

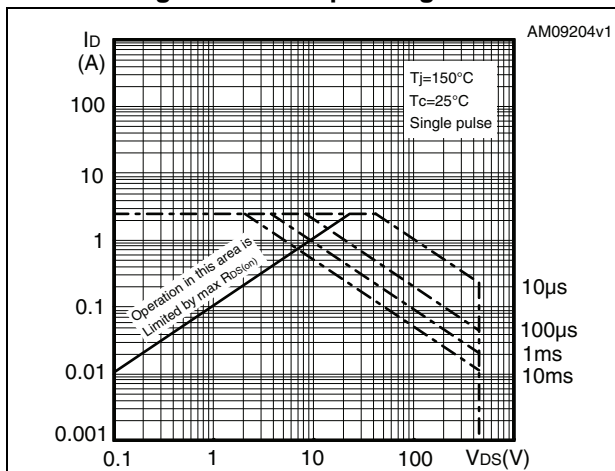

Figure 3. Thermal impedance

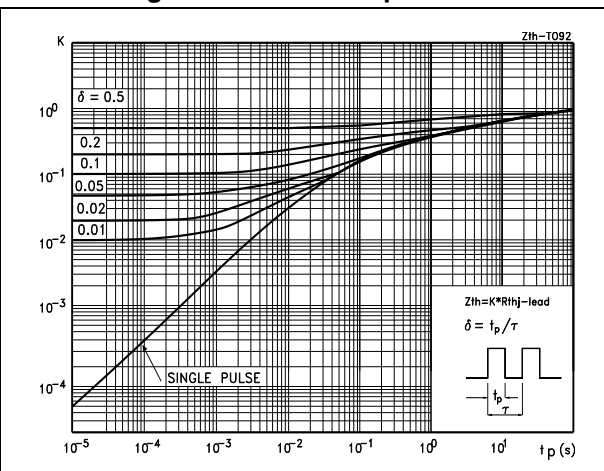

Figure 4. Output characteristics

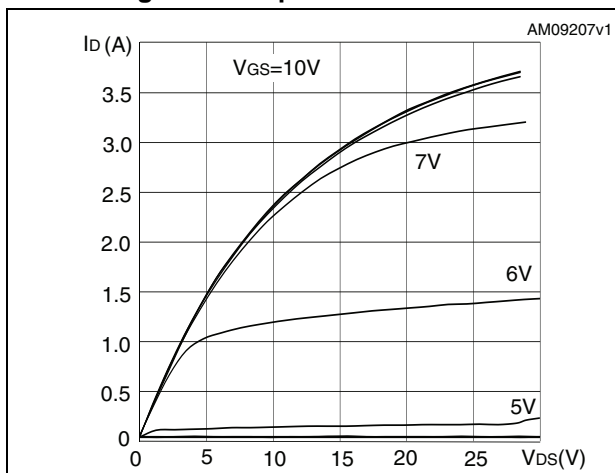

Figure 5. Transfer characteristics

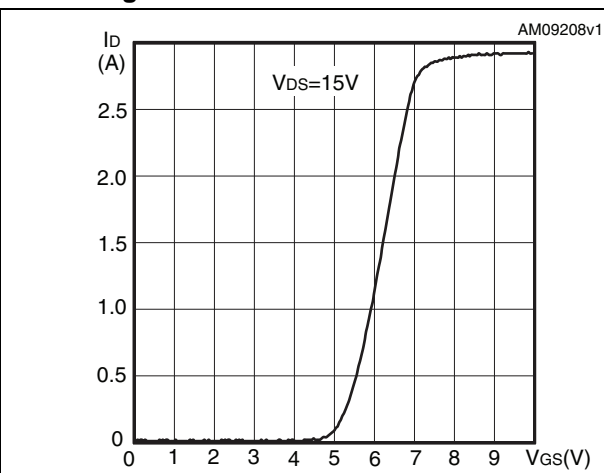

Figure 6. Gate charge vs gate-source voltage

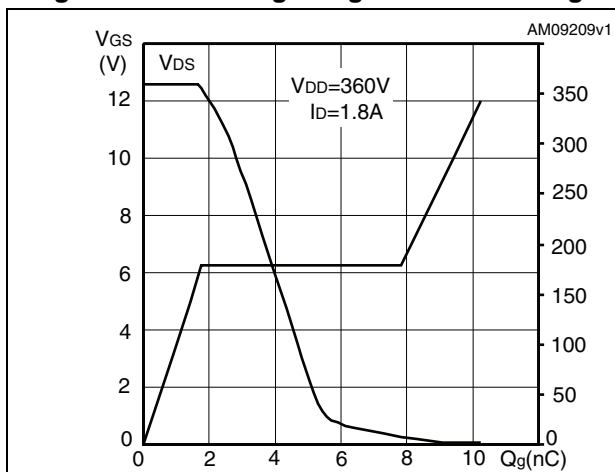

Figure 7. Static drain-source on resistance

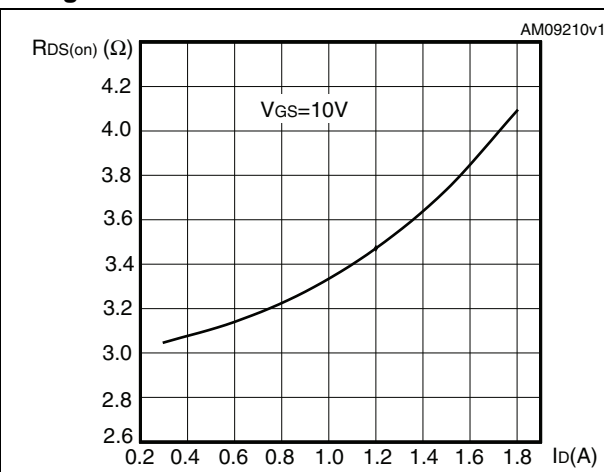

Figure 8. Capacitance variations

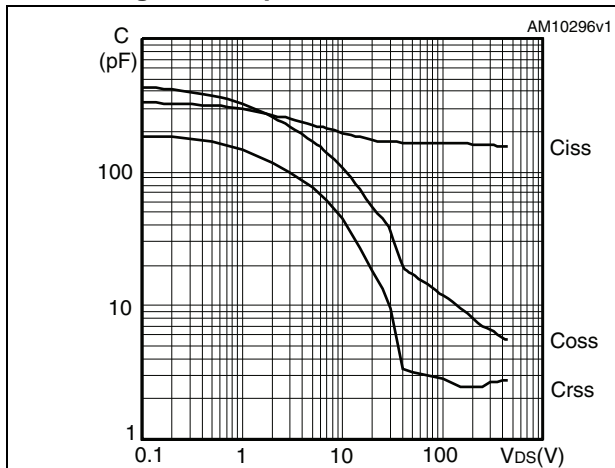

Figure 9. Output capacitance stored energy

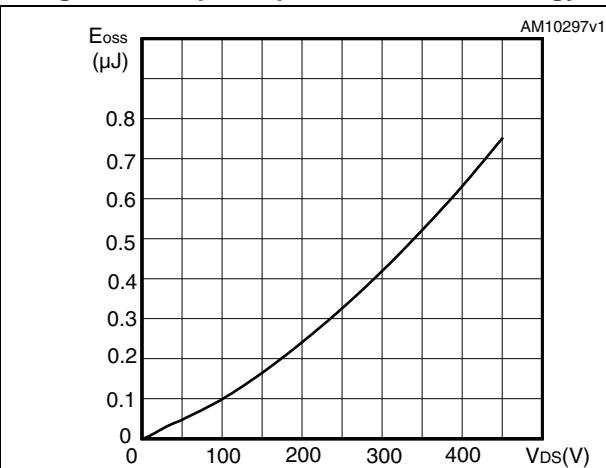

Figure 10. Normalized gate threshold voltage vs temperature

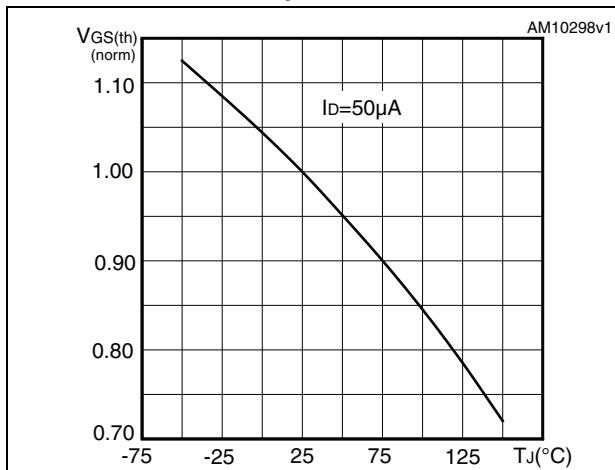

Figure 11. Normalized on-resistance vs temperature

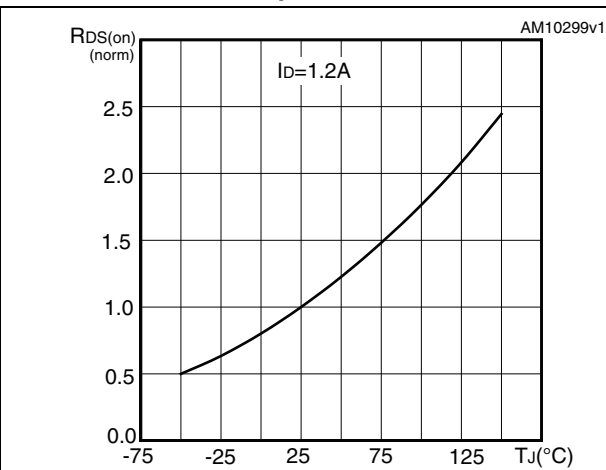

Figure 12. Source-drain diode forward characteristics

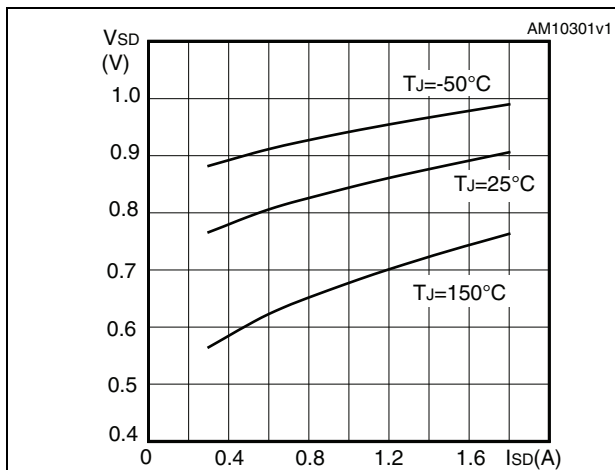

Figure 13. Normalized B_{VDS} vs temperature

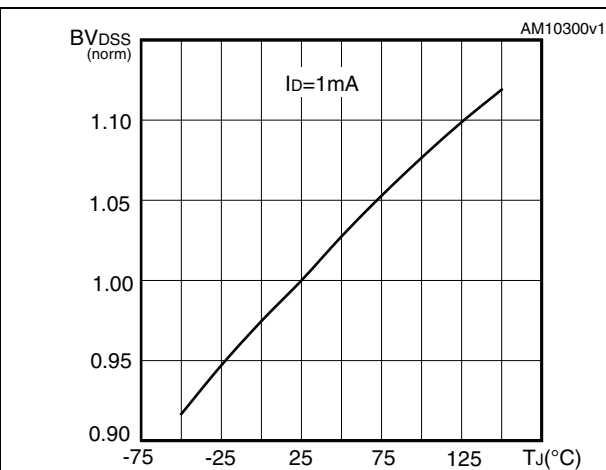
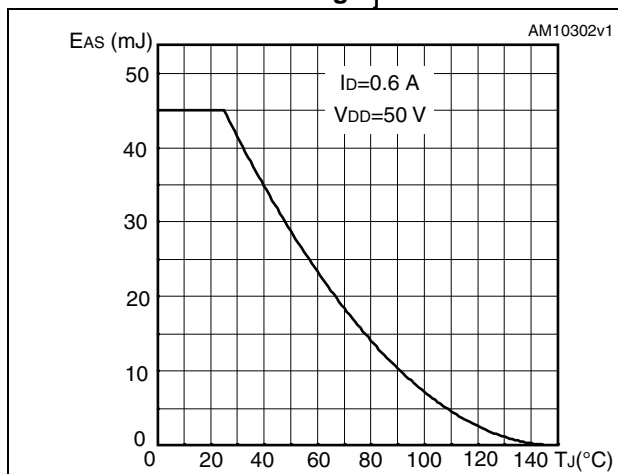

Figure 14. Maximum avalanche energy vs starting T_j



3 Test circuits

Figure 15. Switching times test circuit for resistive load



Figure 16. Gate charge test circuit



Figure 17. Test circuit for inductive load switching and diode recovery times



Figure 18. Unclamped inductive load test circuit



Figure 19. Unclamped inductive waveform



Figure 20. Switching time waveform



4 Package mechanical data

In order to meet environmental requirements, ST offers these devices in different grades of ECOPACK[®] packages, depending on their level of environmental compliance. ECOPACK[®] specifications, grade definitions and product status are available at: www.st.com. ECOPACK[®] is an ST trademark.

Table 9. TO-92 ammpack mechanical data

Dim.	mm		
	Min.	Typ.	Max.
A1			4.80
T			3.80
T1			1.60
T2			2.30
d	0.45	0.47	0.48
P0	12.50	12.70	12.90
P2	5.65	6.35	7.05
F1, F2	2.40	2.50	2.94
F3	4.98	5.08	5.48
delta H	-2.00		2.00
W	17.50	18.00	19.00
W0	5.5	6.00	6.5
W1	8.50	9.00	9.25
W2			0.50
H		18.50	21
H3	0.5	1	2
H0	15.50	16.00	18.8
H1		25.0	27.0
D0	3.80	4.00	4.20
t			0.90
L			11.00
l1	3.00		
delta P	-1.00		1.00

Figure 21. TO-92 ammpack mechanical data drawing

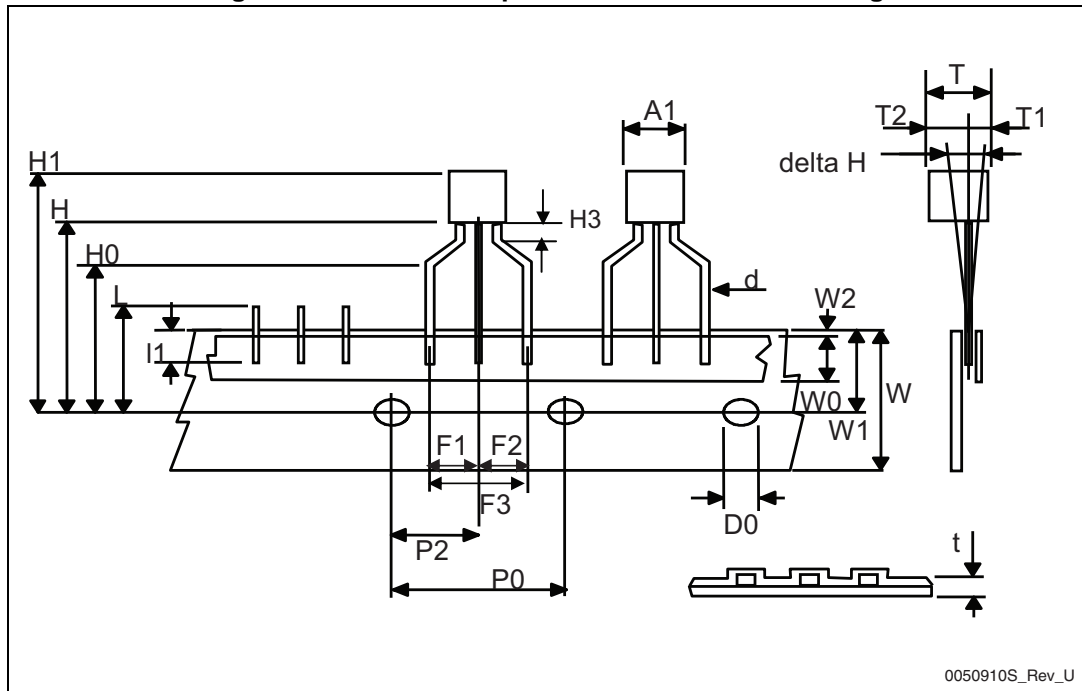

5 Revision history

Table 10. Document revision history

Date	Revision	Changes
24-Jun-2013	1	First release. Part number previously included in datasheet DocID17206

Please Read Carefully:

Information in this document is provided solely in connection with ST products. STMicroelectronics NV and its subsidiaries ("ST") reserve the right to make changes, corrections, modifications or improvements, to this document, and the products and services described herein at any time, without notice.

All ST products are sold pursuant to ST's terms and conditions of sale.

Purchasers are solely responsible for the choice, selection and use of the ST products and services described herein, and ST assumes no liability whatsoever relating to the choice, selection or use of the ST products and services described herein.

No license, express or implied, by estoppel or otherwise, to any intellectual property rights is granted under this document. If any part of this document refers to any third party products or services it shall not be deemed a license grant by ST for the use of such third party products or services, or any intellectual property contained therein or considered as a warranty covering the use in any manner whatsoever of such third party products or services or any intellectual property contained therein.

UNLESS OTHERWISE SET FORTH IN ST'S TERMS AND CONDITIONS OF SALE ST DISCLAIMS ANY EXPRESS OR IMPLIED WARRANTY WITH RESPECT TO THE USE AND/OR SALE OF ST PRODUCTS INCLUDING WITHOUT LIMITATION IMPLIED WARRANTIES OF MERCHANTABILITY, FITNESS FOR A PARTICULAR PURPOSE (AND THEIR EQUIVALENTS UNDER THE LAWS OF ANY JURISDICTION), OR INFRINGEMENT OF ANY PATENT, COPYRIGHT OR OTHER INTELLECTUAL PROPERTY RIGHT.

ST PRODUCTS ARE NOT AUTHORIZED FOR USE IN WEAPONS. NOR ARE ST PRODUCTS DESIGNED OR AUTHORIZED FOR USE IN: (A) SAFETY CRITICAL APPLICATIONS SUCH AS LIFE SUPPORTING, ACTIVE IMPLANTED DEVICES OR SYSTEMS WITH PRODUCT FUNCTIONAL SAFETY REQUIREMENTS; (B) AERONAUTIC APPLICATIONS; (C) AUTOMOTIVE APPLICATIONS OR ENVIRONMENTS, AND/OR (D) AEROSPACE APPLICATIONS OR ENVIRONMENTS. WHERE ST PRODUCTS ARE NOT DESIGNED FOR SUCH USE, THE PURCHASER SHALL USE PRODUCTS AT PURCHASER'S SOLE RISK, EVEN IF ST HAS BEEN INFORMED IN WRITING OF SUCH USAGE, UNLESS A PRODUCT IS EXPRESSLY DESIGNATED BY ST AS BEING INTENDED FOR "AUTOMOTIVE, AUTOMOTIVE SAFETY OR MEDICAL" INDUSTRY DOMAINS ACCORDING TO ST PRODUCT DESIGN SPECIFICATIONS. PRODUCTS FORMALLY ESCC, QML OR JAN QUALIFIED ARE DEEMED SUITABLE FOR USE IN AEROSPACE BY THE CORRESPONDING GOVERNMENTAL AGENCY.

Resale of ST products with provisions different from the statements and/or technical features set forth in this document shall immediately void any warranty granted by ST for the ST product or service described herein and shall not create or extend in any manner whatsoever, any liability of ST.

ST and the ST logo are trademarks or registered trademarks of ST in various countries.

Information in this document supersedes and replaces all information previously supplied.

The ST logo is a registered trademark of STMicroelectronics. All other names are the property of their respective owners.

© 2013 STMicroelectronics - All rights reserved

STMicroelectronics group of companies

Australia - Belgium - Brazil - Canada - China - Czech Republic - Finland - France - Germany - Hong Kong - India - Israel - Italy - Japan - Malaysia - Malta - Morocco - Philippines - Singapore - Spain - Sweden - Switzerland - United Kingdom - United States of America

www.st.com

Mouser Electronics

Authorized Distributor

Click to View Pricing, Inventory, Delivery & Lifecycle Information:

[STMicroelectronics:](#)

[STQ3N45K3-AP](#)