

## N-channel 600 V, 0.065 $\Omega$ typ., 40 A MDmesh™ DM2 Power MOSFET in a TO-247 package

Datasheet - production data

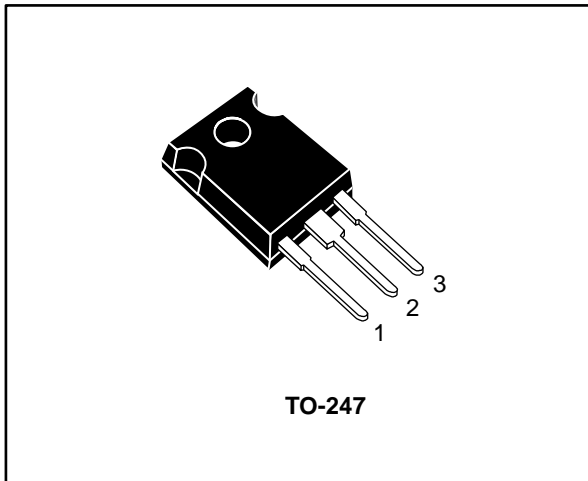
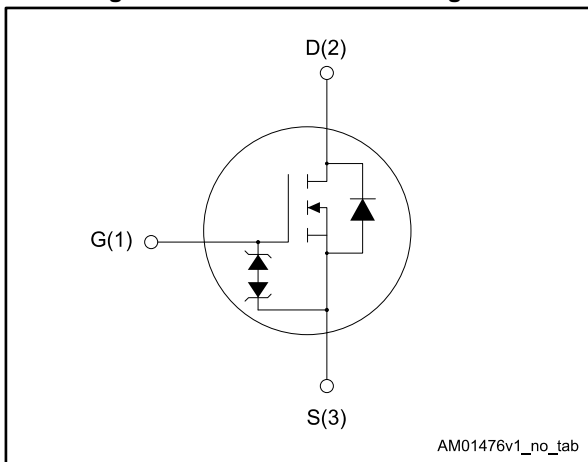

Figure 1: Internal schematic diagram



### Features

Order code	V <sub>DS</sub>	R <sub>DS(on)</sub> max.	I <sub>D</sub>
STW48N60DM2	600 V	0.079 $\Omega$	40 A

- Fast-recovery body diode
- Extremely low gate charge and input capacitance
- Low on-resistance
- 100% avalanche tested
- Extremely high dv/dt ruggedness
- Zener-protected

### Applications

- Switching applications

### Description

This high voltage N-channel Power MOSFET is part of the MDmesh™ DM2 fast recovery diode series. It offers very low recovery charge ( $Q_{rr}$ ) and time ( $t_{rr}$ ) combined with low  $R_{DS(on)}$ , rendering it suitable for the most demanding high efficiency converters and ideal for bridge topologies and ZVS phase-shift converters.

Table 1: Device summary

Order code	Marking	Package	Packing
STW48N60DM2	48N60DM2	TO-247	Tube

---

## Contents

<b>1</b>	<b>Electrical ratings .....</b>	<b>3</b>
<b>2</b>	<b>Electrical characteristics .....</b>	<b>4</b>
	2.1 Electrical characteristics (curves).....	6
<b>3</b>	<b>Test circuits .....</b>	<b>8</b>
<b>4</b>	<b>Package information .....</b>	<b>9</b>
	4.1 TO-247 package information.....	9
<b>5</b>	<b>Revision history .....</b>	<b>11</b>

# 1 Electrical ratings

**Table 2: Absolute maximum ratings**

Symbol	Parameter	Value	Unit
$V_{GS}$	Gate-source voltage	$\pm 25$	V
$I_D$	Drain current (continuous) at $T_{case} = 25\text{ }^\circ\text{C}$	40	A
	Drain current (continuous) at $T_{case} = 100\text{ }^\circ\text{C}$	25	
$I_{DM}^{(1)}$	Drain current (pulsed)	160	A
$P_{TOT}$	Total dissipation at $T_{case} = 25\text{ }^\circ\text{C}$	300	W
$dv/dt^{(2)}$	Peak diode recovery voltage slope	50	V/ns
$dv/dt^{(3)}$	MOSFET $dv/dt$ ruggedness		
$T_{stg}$	Storage temperature	-55 to 150	$^\circ\text{C}$
$T_j$	Operating junction temperature		

**Notes:**

(1) Pulse width is limited by safe operating area.

(2)  $I_{SD} \leq 40\text{ A}$ ,  $di/dt=900\text{ A}/\mu\text{s}$ ;  $V_{DS\text{ peak}} < V_{(BR)DSS}$ ,  $V_{DD} = 400\text{ V}$ .

(3)  $V_{DS} \leq 480\text{ V}$ .

**Table 3: Thermal data**

Symbol	Parameter	Value	Unit
$R_{thj-case}$	Thermal resistance junction-case	0.42	$^\circ\text{C}/\text{W}$
$R_{thj-amb}$	Thermal resistance junction-ambient	50	

**Table 4: Avalanche characteristics**

Symbol	Parameter	Value	Unit
$I_{AR}$	Avalanche current, repetitive or not repetitive (Pulse width limited by $T_{jmax}$ )	7	A
$E_{AR}$	Single pulse avalanche energy (starting $T_j = 25\text{ }^\circ\text{C}$ , $I_D = I_{AR}$ , $V_{DD} = 50\text{ V}$ )	950	mJ

## 2 Electrical characteristics

( $T_{\text{case}} = 25\text{ °C}$  unless otherwise specified)

**Table 5: Static**

Symbol	Parameter	Test conditions	Min.	Typ.	Max.	Unit
$V_{(BR)DSS}$	Drain-source breakdown voltage	$V_{GS} = 0\text{ V}$ , $I_D = 1\text{ mA}$	600			V
$I_{DSS}$	Zero gate voltage drain current	$V_{GS} = 0\text{ V}$ , $V_{DS} = 600\text{ V}$			1	$\mu\text{A}$
		$V_{GS} = 0\text{ V}$ , $V_{DS} = 600\text{ V}$ , $T_{\text{case}} = 125\text{ °C}$			100	
$I_{GSS}$	Gate-body leakage current	$V_{DS} = 0\text{ V}$ , $V_{GS} = \pm 25\text{ V}$			$\pm 5$	$\mu\text{A}$
$V_{GS(th)}$	Gate threshold voltage	$V_{DS} = V_{GS}$ , $I_D = 250\text{ }\mu\text{A}$	3	4	5	V
$R_{DS(on)}$	Static drain-source on-resistance	$V_{GS} = 10\text{ V}$ , $I_D = 20\text{ A}$		0.065	0.079	$\Omega$

**Table 6: Dynamic**

Symbol	Parameter	Test conditions	Min.	Typ.	Max.	Unit
$C_{iss}$	Input capacitance	$V_{DS} = 100\text{ V}$ , $f = 1\text{ MHz}$ , $I_D = 0\text{ A}$	-	3250	-	$\mu\text{F}$
$C_{oss}$	Output capacitance		-	142	-	
$C_{rss}$	Reverse transfer capacitance		-	4.5	-	
$C_{oss\text{ eq.}}^{(1)}$	Equivalent output capacitance	$V_{DS} = 0\text{ to }480\text{ V}$ , $V_{GS} = 0\text{ V}$	-	258	-	$\mu\text{F}$
$R_G$	Intrinsic gate resistance	$f = 1\text{ MHz}$ , $I_D = 0\text{ A}$	-	4	-	$\Omega$
$Q_g$	Total gate charge	$V_{DD} = 480\text{ V}$ , $I_D = 40\text{ A}$ , $V_{GS} = 10\text{ V}$ (see <a href="#">Figure 14: "Test circuit for gate charge behavior"</a> )	-	70	-	nC
$Q_{gs}$	Gate-source charge		-	18	-	
$Q_{gd}$	Gate-drain charge		-	28	-	

**Notes:**

<sup>(1)</sup>  $C_{oss\text{ eq.}}$  is defined as a constant equivalent capacitance giving the same charging time as  $C_{oss}$  when  $V_{DS}$  increases from 0 to 80%  $V_{DSS}$ .

**Table 7: Switching times**

Symbol	Parameter	Test conditions	Min.	Typ.	Max.	Unit
$t_{d(on)}$	Turn-on delay time	$V_{DD} = 300\text{ V}$ , $I_D = 20\text{ A}$ , $R_G = 4.7\text{ }\Omega$ , $V_{GS} = 10\text{ V}$ (see <a href="#">Figure 13: "Test circuit for resistive load switching times"</a> and )	-	27	-	ns
$t_r$	Rise time		-	27	-	
$t_{d(off)}$	Turn-off delay time		-	131	-	
$t_f$	Fall time		-	9.8	-	

Table 8: Source-drain diode

Symbol	Parameter	Test conditions	Min.	Typ.	Max.	Unit
$I_{SD}^{(1)}$	Source-drain current		-		40	A
$I_{SDM}^{(2)}$	Source-drain current (pulsed)		-		160	A
$V_{SD}^{(3)}$	Forward on voltage	$V_{GS} = 0\text{ V}$ , $I_{SD} = 40\text{ A}$	-		1.6	V
$t_{rr}$	Reverse recovery time	$I_{SD} = 40\text{ A}$ , $di/dt = 100\text{ A}/\mu\text{s}$ , $V_{DD} = 60\text{ V}$ (see <a href="#">Figure 15: "Test circuit for inductive load switching and diode recovery times"</a> )	-	140		ns
$Q_{rr}$	Reverse recovery charge		-	0.7		$\mu\text{C}$
$I_{RRM}$	Reverse recovery current		-	10		A
$t_{rr}$	Reverse recovery time	$I_{SD} = 40\text{ A}$ , $di/dt = 100\text{ A}/\mu\text{s}$ , $V_{DD} = 60\text{ V}$ , $T_j = 150\text{ }^\circ\text{C}$ (see <a href="#">Figure 15: "Test circuit for inductive load switching and diode recovery times"</a> )	-	256		ns
$Q_{rr}$	Reverse recovery charge		-	2.5		$\mu\text{C}$
$I_{RRM}$	Reverse recovery current		-	20		A

**Notes:**

- (1) Limited by maximum junction temperature  
(2) Pulse width is limited by safe operating area.  
(3) Pulse test: pulse duration = 300  $\mu\text{s}$ , duty cycle 1.5%.

Table 9: Gate-source Zener diode

Symbol	Parameter	Test conditions	Min.	Typ.	Max.	Unit
$V_{(BR)GSO}$	Gate-source breakdown voltage	$I_{GS} = \pm 250\text{ }\mu\text{A}$ , $I_D = 0\text{ A}$	$\pm 30$	-	-	V

The built-in back-to-back Zener diodes are specifically designed to enhance the ESD performance of the device. The Zener voltage facilitates efficient and cost-effective device integrity protection, thus eliminating the need for additional external componentry.

## 2.2 Electrical characteristics (curves)

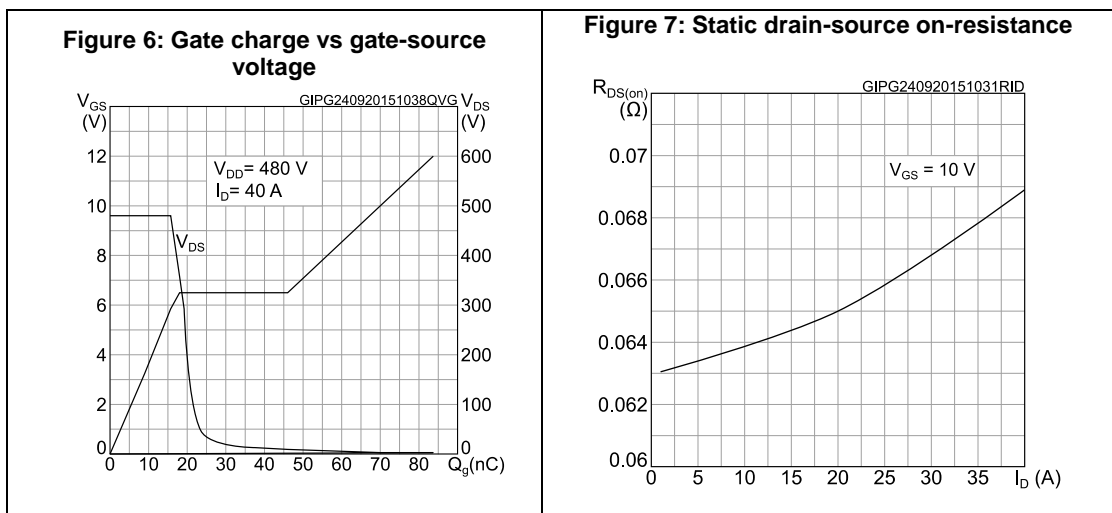
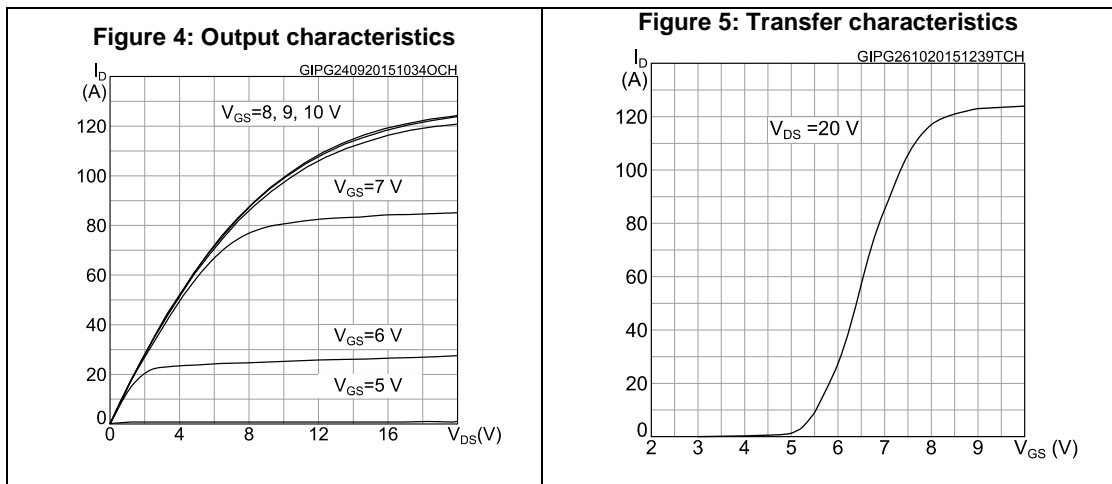
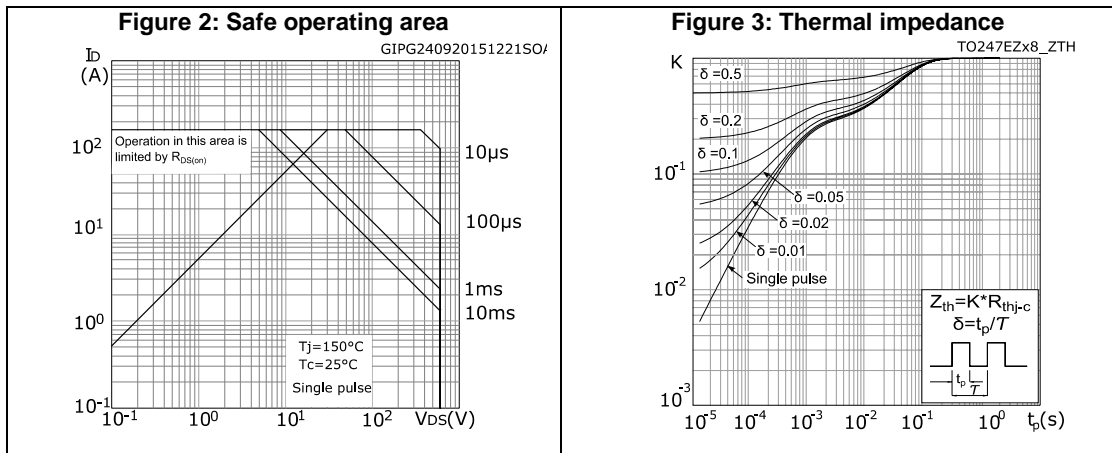

Figure 8: Capacitance variations

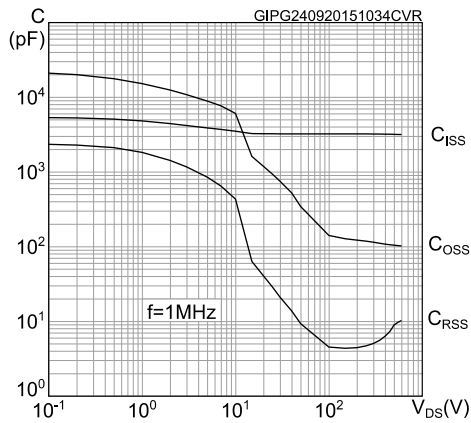

Figure 9: Normalized gate threshold voltage vs temperature

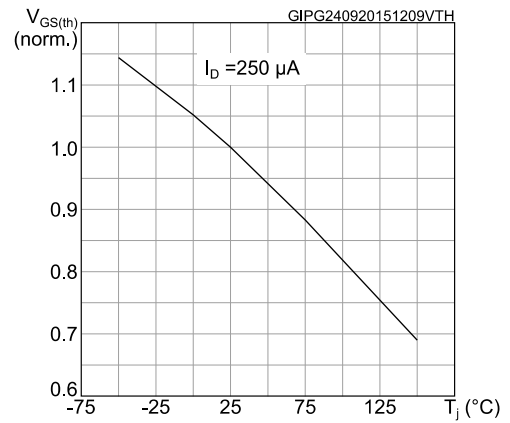

Figure 10: Normalized on-resistance vs temperature

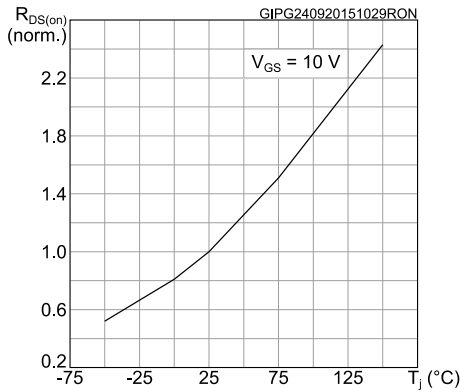

Figure 11: Normalized V(BR)DSS vs temperature

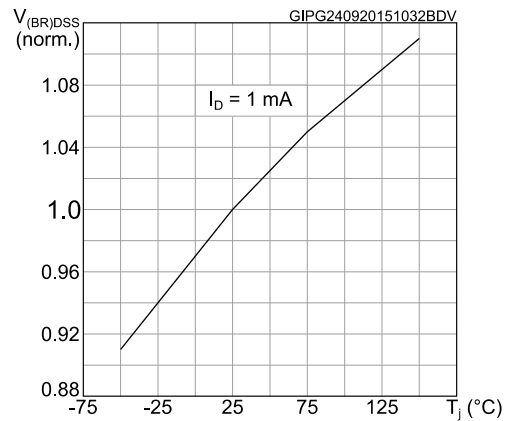
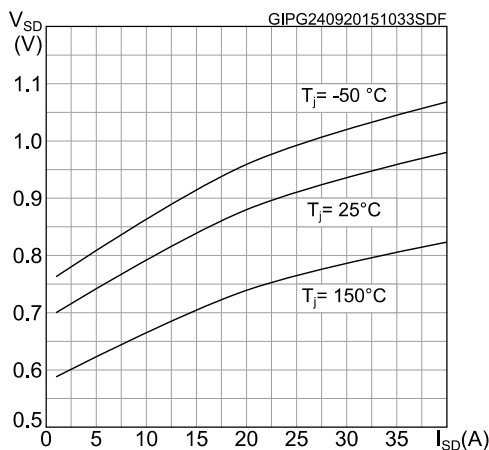
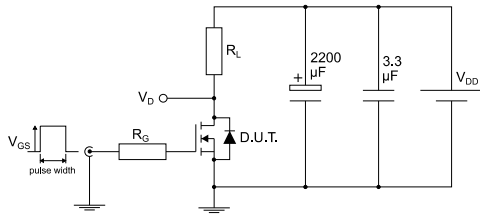

Figure 12: Source- drain diode forward characteristics



### 3 Test circuits

**Figure 13: Test circuit for resistive load switching times**



AM01468v1

**Figure 14: Test circuit for gate charge behavior**

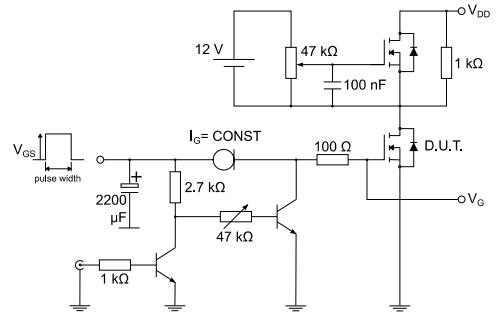

AM01469v1

**Figure 15: Test circuit for inductive load switching and diode recovery times**

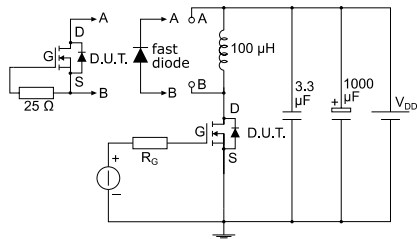

AM01470v1

**Figure 16: Unclamped inductive load test circuit**

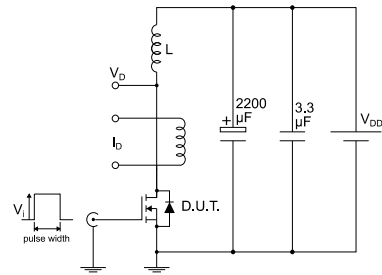

AM01471v1

**Figure 17: Unclamped inductive waveform**

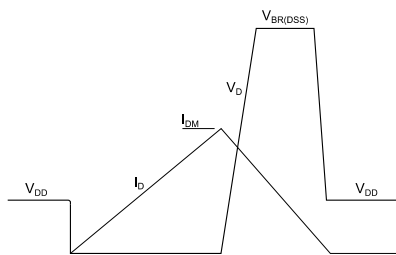

AM01472v1

**Figure 18: Switching time waveform**

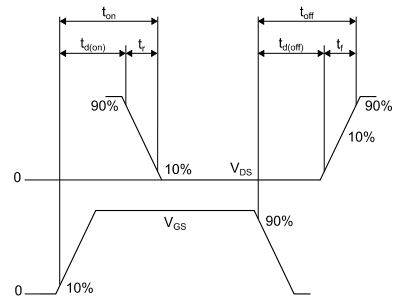

AM01473v1



## 4 Package information

In order to meet environmental requirements, ST offers these devices in different grades of ECOPACK® packages, depending on their level of environmental compliance. ECOPACK® specifications, grade definitions and product status are available at: [www.st.com](http://www.st.com). ECOPACK® is an ST trademark.

### 4.1 TO-247 package information

Figure 19: TO-247 package outline

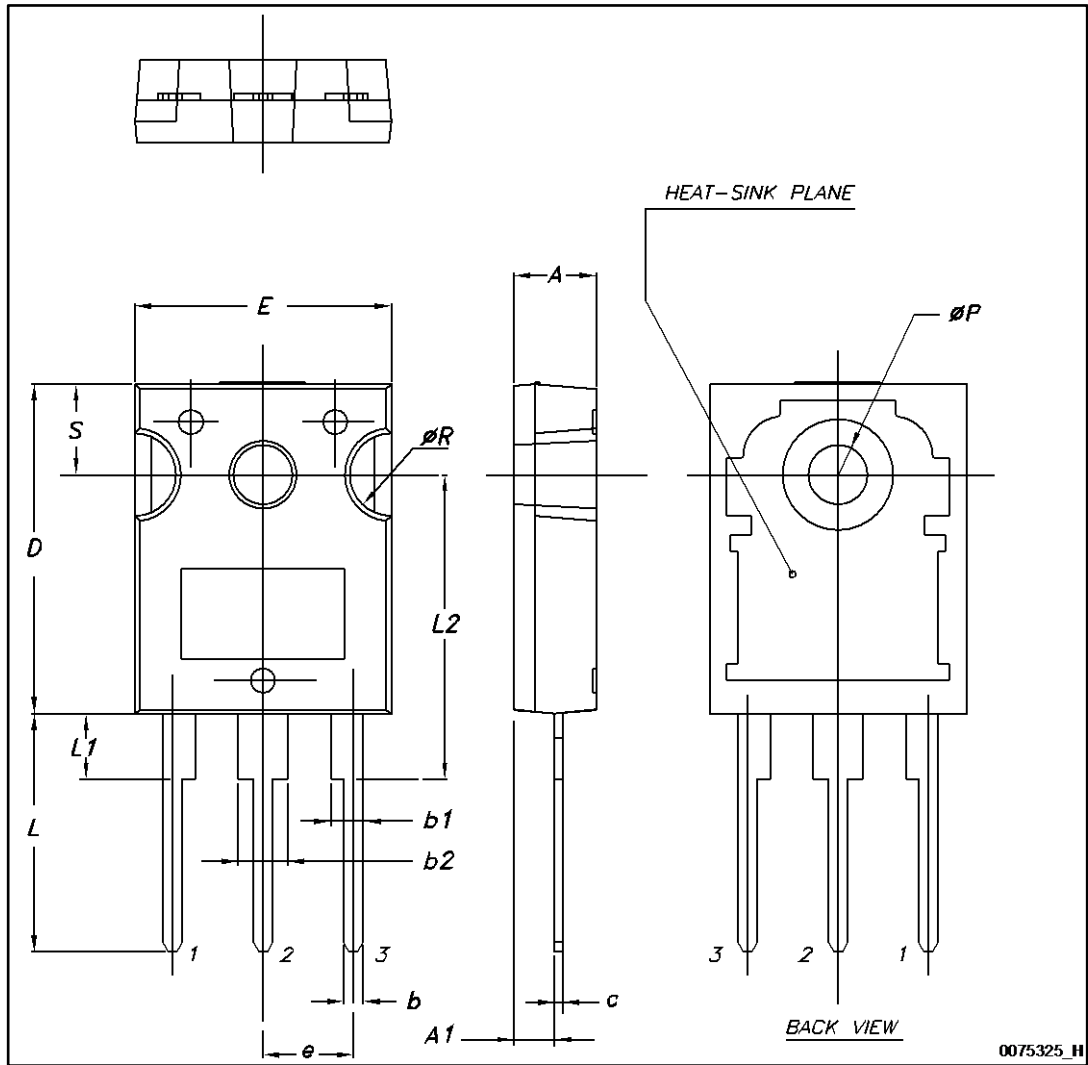

Table 10: TO-247 package mechanical data

Dim.	mm.		
	Min.	Typ.	Max.
A	4.85		5.15
A1	2.20		2.60
b	1.0		1.40
b1	2.0		2.40
b2	3.0		3.40
c	0.40		0.80
D	19.85		20.15
E	15.45		15.75
e	5.30	5.45	5.60
L	14.20		14.80
L1	3.70		4.30
L2		18.50	
ØP	3.55		3.65
ØR	4.50		5.50
S	5.30	5.50	5.70

## 5 Revision history

Table 11: Document revision history

Date	Revision	Changes
21-Oct-2014	1	First release.
29-Oct-2015	2	Document status promoted from preliminary to production data. Modified: title Modified: $V_{DS}$ in cover page Modified: Peak diode recovery voltage slope parameter value and <i>note 2</i> Modified: $R_{thj-case}$ value in <i>Table 3: "Thermal data"</i> Modified: the entire values in <i>Table 4: "Avalanche characteristics"</i> Modified: $I_{DSS}$ , $I_{GSS}$ max values and $R_{DS(on)}$ typical value in <i>Table 5: "Static"</i> Modified: the entire values in <i>Table 6: "Dynamic"</i> , <i>Table 7: "Switching times"</i> and <i>Table 8: "Source-drain diode"</i> Added: <i>Table 9: "Gate-source Zener diode"</i> Added: <i>Section 2.1: "Electrical characteristics (curves)"</i> Minor text changes

**IMPORTANT NOTICE – PLEASE READ CAREFULLY**

STMicroelectronics NV and its subsidiaries ("ST") reserve the right to make changes, corrections, enhancements, modifications, and improvements to ST products and/or to this document at any time without notice. Purchasers should obtain the latest relevant information on ST products before placing orders. ST products are sold pursuant to ST's terms and conditions of sale in place at the time of order acknowledgement.

Purchasers are solely responsible for the choice, selection, and use of ST products and ST assumes no liability for application assistance or the design of Purchasers' products.

No license, express or implied, to any intellectual property right is granted by ST herein.

Resale of ST products with provisions different from the information set forth herein shall void any warranty granted by ST for such product.

ST and the ST logo are trademarks of ST. All other product or service names are the property of their respective owners.

Information in this document supersedes and replaces information previously supplied in any prior versions of this document.

© 2015 STMicroelectronics – All rights reserved

# Mouser Electronics

Authorized Distributor

Click to View Pricing, Inventory, Delivery & Lifecycle Information:

[STMicroelectronics:](#)

[STW48N60DM2](#)