

Description

The TN1515-600B is a 15 A thyristor SCR housed in DPAK package. It fits any high voltage application that requires a high power density and compact housing design.

Table 1. Device summary

Symbol	Value	Unit
$I_{T(RMS)}$	15	A
V_{DRM}/V_{RRM}	600	V
$I_{GT(Q_1)}$	15	mA

Features

- On-state RMS current, $I_{T(RMS)}$: 15 A
- Repetitive peak off-state voltage, V_{DRM}/V_{RRM} : 600 V
- Triggering gate current, I_{GT} : 15 mA
- DPAK surface mount package

Application

- Universal motor DC phase control
- Power supply crowbar circuit
- Power Supply inrush limiter
- Motor soft start controller
- AC-DC voltage regulator

Benefits

- High AC surge current density
- Compact DPAK foot print

1 Characteristics

Table 2. Absolute ratings (limiting values)

Symbol	Parameter		Value	Unit	
$I_{T(RMS)}$	On-state RMS current (180° conduction angle)		$T_c = 109\text{ °C}$	15	A
$I_{T(AV)}$	Average on-state current (180° conduction angle)		$T_c = 109\text{ °C}$	9.5	A
I_{TSM}	Non repetitive surge peak on-state current	$t_p = 8.3\text{ ms}$	$T_j = 25\text{ °C}$	165	A
		$t_p = 10\text{ ms}$		150	
I^2t	I^2t value for fusing	$t_p = 10\text{ ms}$	$T_j = 25\text{ °C}$	113	A ² S
di/dt	Critical rate of rise of on-state current $I_G = 2 \times I_{GT}$, $t_r \leq 100\text{ ns}$	$F = 120\text{ Hz}$	$T_j = 125\text{ °C}$	50	A/ μ s
I_{GM}	Peak gate current	$t_p = 20\text{ }\mu$ s	$T_j = 125\text{ °C}$	4	A
$P_{G(AV)}$	Average gate power dissipation		$T_j = 125\text{ °C}$	1	W
T_{stg} T_j	Storage junction temperature range Operating junction temperature range			- 40 to + 150 - 40 to + 125	°C
V_{RGM}	Maximum peak reverse gate voltage			5	V

Table 3. Standard electrical characteristics ($T_j = 25\text{ °C}$, unless otherwise specified)

Symbol	Test conditions		Values		Unit
I_{GT}	$V_{out} = 12\text{ V}$, $R_L = 33\text{ }\Omega$	$T_j = 25\text{ °C}$	MIN.	2	mA
			MAX.	15	
V_{GT}	$V_{out} = 12\text{ V}$, $R_L = 33\text{ }\Omega$		MAX.	1.3	V
V_{GD}	$V_D = V_{DRM}$, $R_L = 3.3\text{ k}\Omega$	$T_j = 125\text{ °C}$	MIN.	0.2	V
I_H	$I_T = 500\text{ mA}$		MAX.	40	mA
I_L	$I_G = 1.2 I_{GT}$		MAX.	60	mA
dV/dt	$V_D = 67\% V_{DRM}$, gate open	$T_j = 125\text{ °C}$	MIN.	200	V/ μ s
V_{TM}	$I_{TM} = 30\text{ A}$ $t_p = 380\text{ }\mu$ s	$T_j = 25\text{ °C}$	MAX.	1.6	V
V_{TO}	Threshold voltage		MAX.	0.85	V
R_D	Dynamic resistance		MAX.	25	m Ω
I_{DRM} I_{RRM}	$V_D/V_R = V_{DRM} = V_{RRM}$	$T_j = 25\text{ °C}$	MAX.	5	μ A
		$T_j = 125\text{ °C}$		2	mA

Table 4. Thermal resistance

Symbol	Parameter	Value	Unit
$R_{th(j-c)}$	Junction to case (DC)	1.2	$^{\circ}\text{C}/\text{W}$
$R_{th(j-a)}$	Junction to ambient	$S^{(1)} = 0.5 \text{ cm}^2$	$^{\circ}\text{C}/\text{W}$

1. S = Copper surface under tab

Figure 1. Maximum average power dissipation versus average on-state current

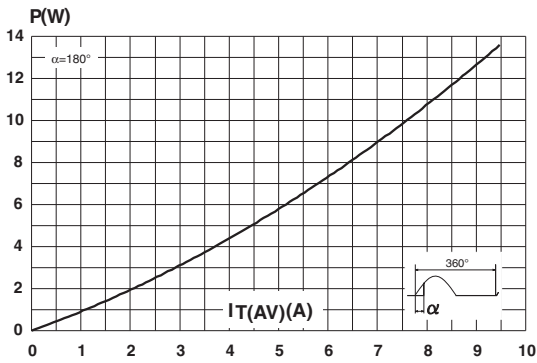

Figure 2. Average and DC on-state current versus case temperature

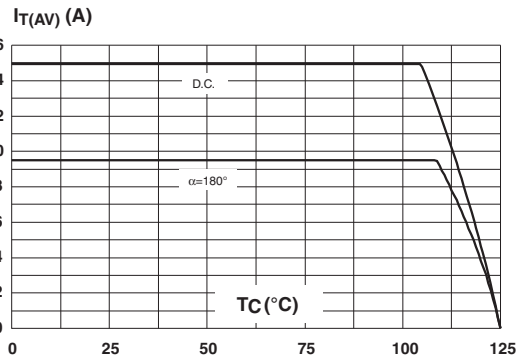

Figure 3. Average and DC on-state current versus ambient temperature, PCB FR4, copper thickness 35 μm

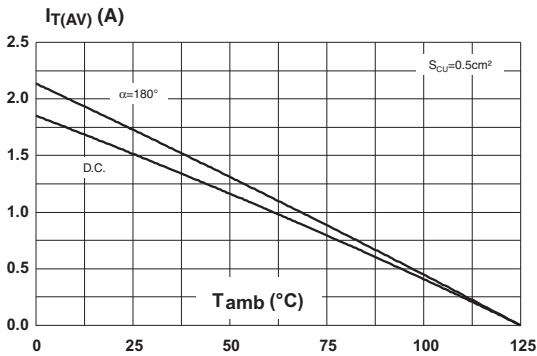

Figure 4. Thermal impedance junction to ambient versus pulse duration, PCB FR4, copper thickness 35 μm

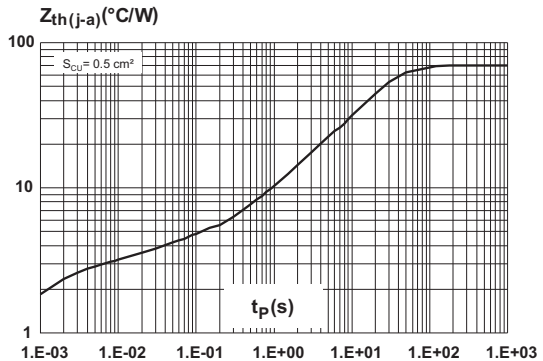

Figure 5. Relative variation of gate trigger current, holding current and latching current versus junction temperature (typical values)

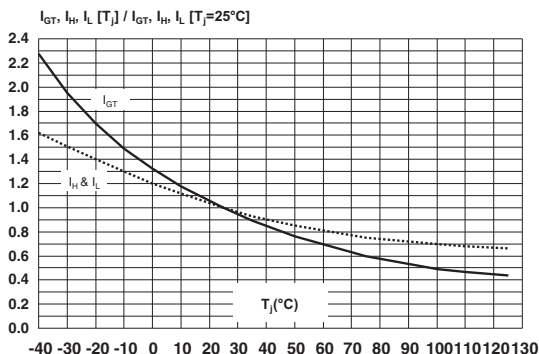

Figure 6. Surge peak on-state current versus number of cycles

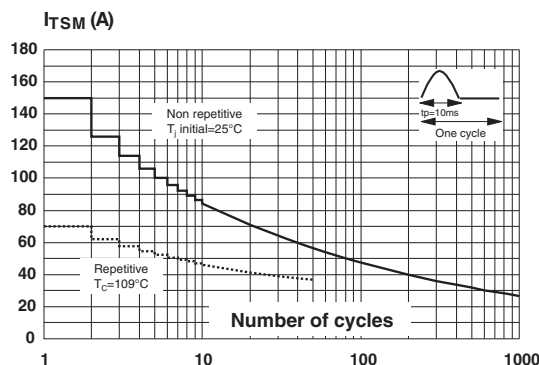

Figure 7. Non-repetitive surge peak on-state current for a sinusoidal pulse with width $t_p < 10$ ms

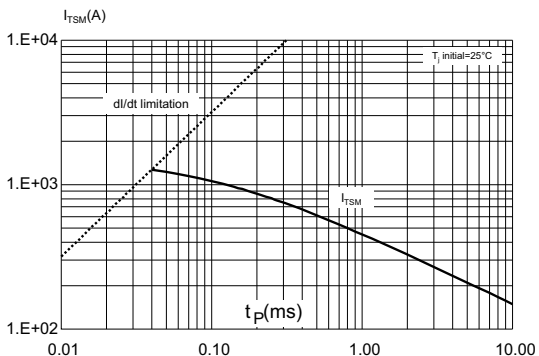

Figure 8. On-state characteristics (maximum values)

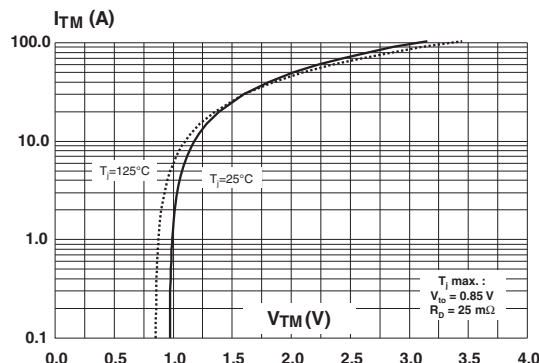
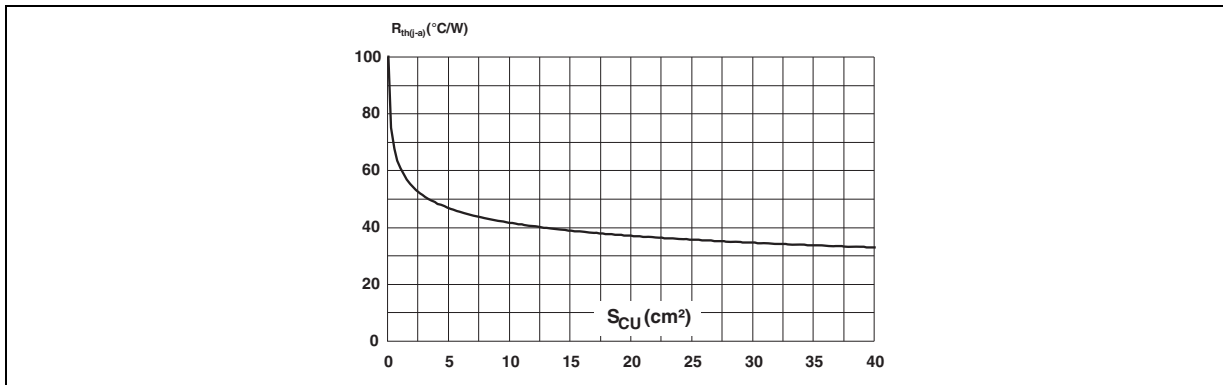

Figure 9. Junction to ambient thermal resistance versus copper surface under tab, PCB FR4, copper thickness 35µm



2 Package information

- Epoxy meets UL94, V0
- Lead-free packages
- Halogen-free molding resin
- Recommended torque: 0.4 to 0.6 N·m

In order to meet environmental requirements, ST offers these devices in different grades of ECOPACK® packages, depending on their level of environmental compliance. ECOPACK® specifications, grade definitions and product status are available at: www.st.com. ECOPACK® is an ST trademark.

2.1 DPAK package information

Figure 10. DPAK package outline

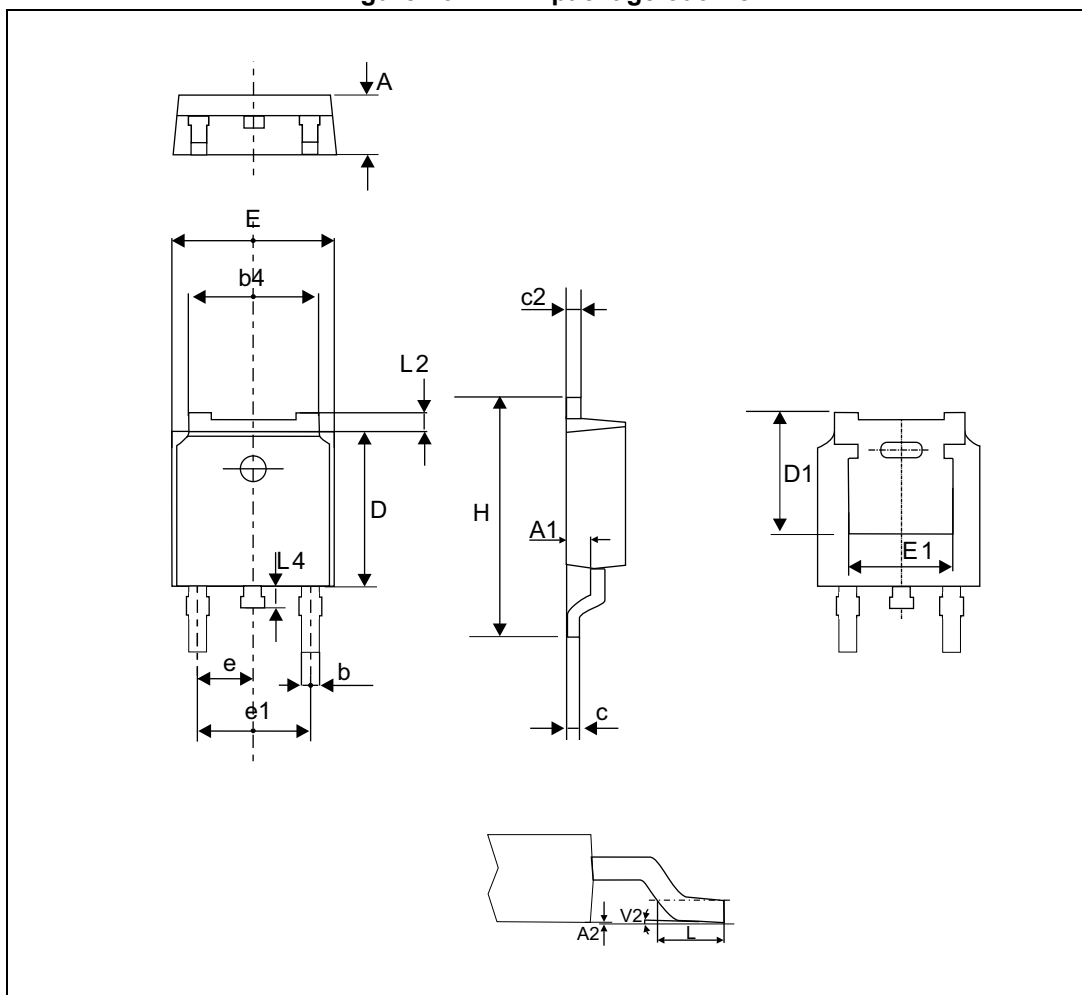

Note: This package drawing may slightly differ from the physical package. However, all the specified dimensions are guaranteed.

Table 5. DPAK package mechanical data

Ref.	Dimensions					
	Millimeters			Inches		
	Min.	Typ.	Max.	Min.	Typ.	Max.
A	2.18		2.40	0.086		0.0944
A1	0.9		1.10	0.035		0.0433
A2	0.03		0.23	0.0011		0.0090
b	0.64		0.90	0.0251		0.0354
b4	4.95		5.46	0.1948		0.2149
c	0.46		0.61	0.0181		0.0240
c2	0.46		0.60	0.0181		0.0236
D	5.97		6.22	0.2350		0.2448
D1	4.95			0.1948		
E	6.35		6.73	0.2500		0.2649
E1	4.32			0.1700		
e		2.286			0.09	
e1		4.572			0.18	
H	9.35		10.40	0.3681		0.4094
L	1.0		1.78	0.039		0.0700
L2			1.27			0.0500
L4	0.6		1.02	0.023		0.0401
V2	-8°		+8°	-8°		+8°

Figure 11. Footprint (dimensions in mm)

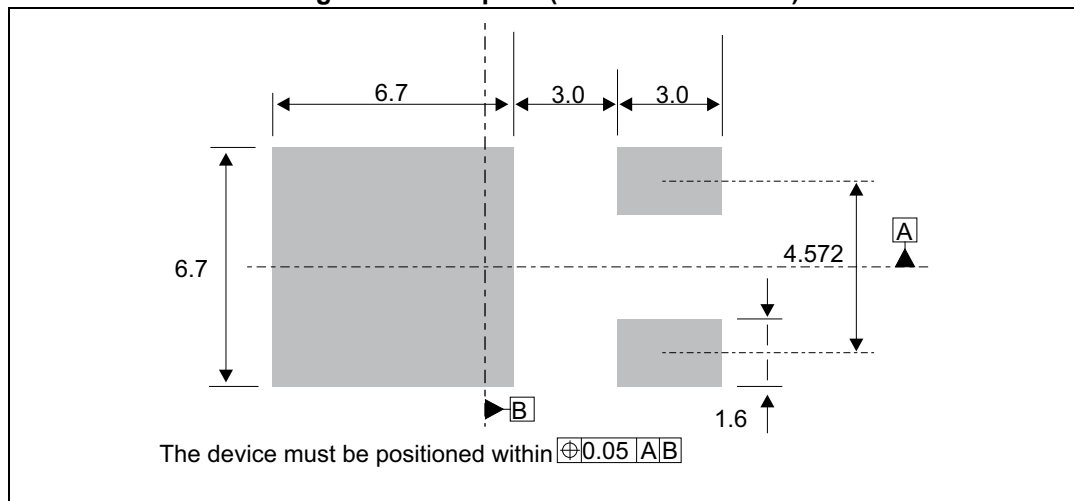

Note: This package drawing may slightly differ from the physical package. However, all the specified dimensions are guaranteed.

3 Ordering information

Figure 12. Ordering information schema

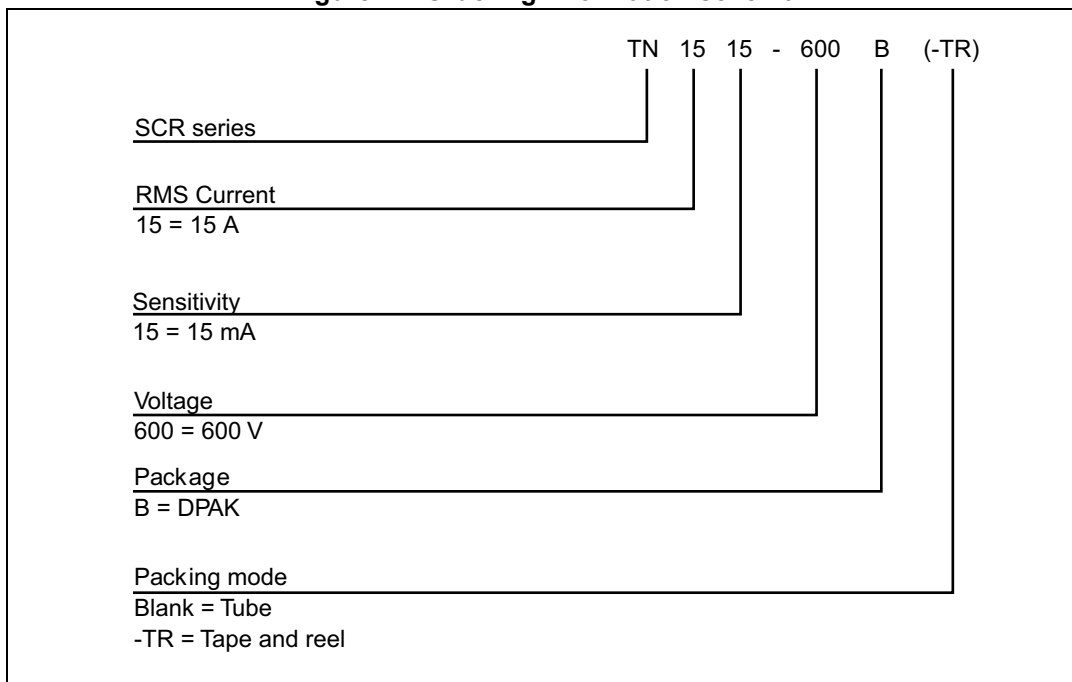

Table 6. Ordering information

Order code	Marking	Package	Weight	Base qty	Delivery mode
TN1515-600B	TN15 15600	DPAK	0.3 g	75	Tube
TN1515-600B-TR	TN15 15600	DPAK	0.3 g	2500	Tape and reel

4 Revision history

Table 7. Document revision history

Date	Revision	Changes
13-Mar-2006	1	Last update.
11-Jul-2007	2	TO-220AB delivery mode changed from bulk to tube.
21-Sep-2015	3	Updated Features , Application , Description and Benefits on cover page. Updated Figure 7 , package information and reformatted to current standard.

IMPORTANT NOTICE – PLEASE READ CAREFULLY

STMicroelectronics NV and its subsidiaries ("ST") reserve the right to make changes, corrections, enhancements, modifications, and improvements to ST products and/or to this document at any time without notice. Purchasers should obtain the latest relevant information on ST products before placing orders. ST products are sold pursuant to ST's terms and conditions of sale in place at the time of order acknowledgement.

Purchasers are solely responsible for the choice, selection, and use of ST products and ST assumes no liability for application assistance or the design of Purchasers' products.

No license, express or implied, to any intellectual property right is granted by ST herein.

Resale of ST products with provisions different from the information set forth herein shall void any warranty granted by ST for such product.

ST and the ST logo are trademarks of ST. All other product or service names are the property of their respective owners.

Information in this document supersedes and replaces information previously supplied in any prior versions of this document.

© 2015 STMicroelectronics – All rights reserved

Mouser Electronics

Authorized Distributor

Click to View Pricing, Inventory, Delivery & Lifecycle Information:

[STMicroelectronics:](#)

[TN1515-600B](#) [TN1515-600B-TR](#)