

40 A high voltage Triacs

Datasheet - production data

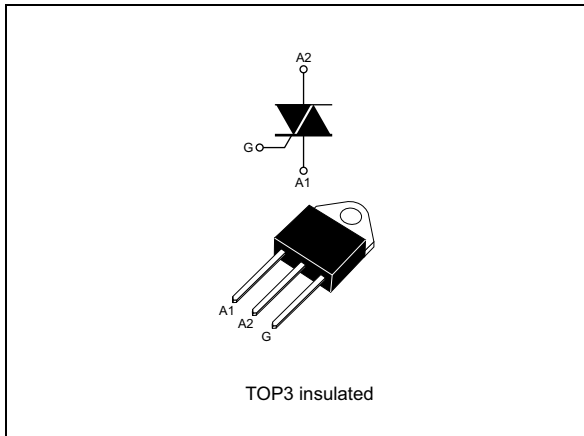

Description

The TPDVxx40 series use a high performance alternistor technology. Featuring very high commutation levels and high surge current capability, this family is well adapted to power control on inductive load (motor, transformer...).

Table 1. Device summary

Parameter	Blocking voltage V_{DRM}/V_{RRM}	On-state current $I_{T(RMS)}$	Gate current I_{GT}
TPDV640RG	600 V	40 A	200 mA
TPDV840RG	800 V		
TPDV1240RG	1200 V		

Features

- On-state current ($I_{T(RMS)}$): 40 A
- Max. blocking voltage (V_{DRM}/V_{RRM}): 1200 V
- Gate current (I_{GT}): 200 mA
- Commutation at 10 V/ μ s: up to 142 A/ms
- Noise immunity: 500 V/ μ s
- Insulated package:
 - 2,500 V rms (UL recognized: E81734)

1 Characteristics

Table 2. Absolute ratings (limiting values)

Symbol	Parameter		Value	Unit	
$I_{T(RMS)}$	On-state rms current (180° conduction angle)		$T_c = 75\text{ °C}$ 40	A	
I_{TSM}	Non repetitive surge peak on-state current	$t_p = 2.5\text{ ms}$	$T_j = 25\text{ °C}$	590	A
		$t_p = 8.3\text{ ms}$		370	
		$t_p = 10\text{ ms}$		350	
I^2t	I^2t value for fusing	$t_p = 10\text{ ms}$	$T_j = 25\text{ °C}$	610	A ² S
di/dt	Critical rate of rise of on-state current $I_G = 500\text{ mA}; di_G/dt = 1\text{ A}/\mu\text{s}$	Repetitive $F = 50\text{ Hz}$		20	A/ μs
		Non repetitive		100	
V_{DRM} V_{RRM}	Repetitive peak off-state voltage	TPDV640	$T_j = 125\text{ °C}$	600	V
		TPDV840		800	
		TPDV1240		1200	
T_{stg} T_j	Storage junction temperature range		-40 to +150		°C
	Operating junction temperature range		-40 to +125		
T_L	Maximum lead temperature for soldering during 10 s at 2 mm from case		260	°C	
$V_{INS(RMS)}^{(1)}$	Insulation rms voltage		2500	V	

1. A1, A2, gate terminals to case for 1 minute

Table 3. Electrical Characteristics ($T_j = 25\text{ °C}$, unless otherwise specified)

Symbol	Test condition	Quadrant		Value	Unit	
I_{GT}	$V_D = 12\text{ V DC}, R_L = 33\ \Omega$	I - II - III	Max.	200	mA	
V_{GT}			Max.	1.5	V	
V_{GD}	$V_D = V_{DRM}, R_L = 3.3\text{ k}\Omega$	$T_j = 125\text{ °C}$	I - II - III	Min.	0.2	V
t_{gt}	$V_D = V_{DRM}, I_G = 500\text{ mA}, di_G/dt = 3\text{ A}/\mu\text{s}$		I - II - III	Typ.	2.5	μs
$I_H^{(1)}$	$I_T = 500\text{ mA}$ Gate open			Typ.	50	mA
I_L	$I_G = 1.2 \times I_{GT}$		I - III	Typ.	100	mA
			II		200	
dV/dt	Linear slope up to : $V_D = 67\% V_{DRM}$ Gate open	$T_j = 125\text{ °C}$		Min.	500	V/ μs
$V_{TM}^{(1)}$	$I_{TM} = 56\text{ A}, t_p = 380\ \mu\text{s}$			Max.	1.8	V
I_{DRM} I_{RRM}	$V_{DRM} = V_{RRM}$	$T_j = 25\text{ °C}$		Max.	20	μA
		$T_j = 125\text{ °C}$			8	mA
$(di/dt)_c^{(1)}$	$(dV/dt)_c = 200\text{ V}/\mu\text{s}$		$T_j = 125\text{ °C}$	Min.	35	A/ms
	$(dV/dt)_c = 10\text{ V}/\mu\text{s}$				142	

1. For either polarity of electrode A₂ voltage with reference to electrode A₁.

Table 4. Gate characteristics (maximum values)

Symbol	Parameter	Value	Unit
$P_{G(AV)}$	Average gate power dissipation	1	W
P_{GM}	Peak gate power dissipation	$t_p = 20 \mu s$ 40	W
I_{GM}	Peak gate current	$t_p = 20 \mu s$ 8	A
V_{GM}	Peak positive gate voltage	$t_p = 20 \mu s$ 16	V

Table 5. Thermal resistance

Symbol	Parameter	Value	Unit
$R_{th(j-a)}$	Junction to ambient	50	$^{\circ}C/W$
$R_{th(j-c) DC}$	Junction to case for DC	1.2	$^{\circ}C/W$
$R_{th(j-c) AC}$	Junction to case for 360 $^{\circ}$ conduction angle (F = 50 Hz)	0.9	$^{\circ}C/W$

Figure 1. Max. rms power dissipation versus on-state rms current (F = 50 Hz) (curves limited by (dI/dt)c)

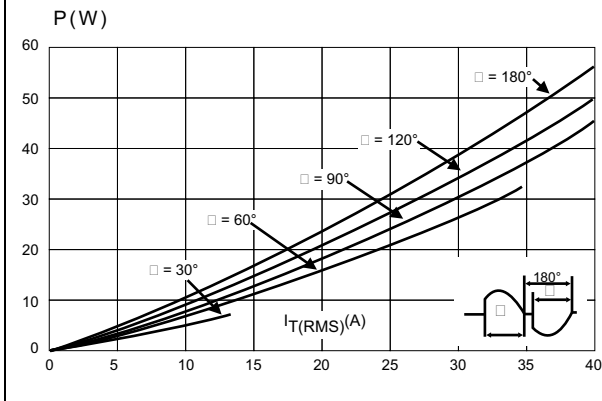

Figure 2. Max. rms power dissipation and max. allowable temperatures (T_{amb} and T_{case}) for various R_{th}

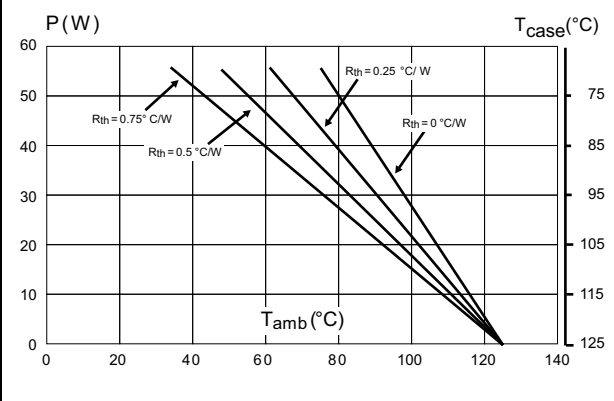

Figure 3. On-state rms current versus case temperature

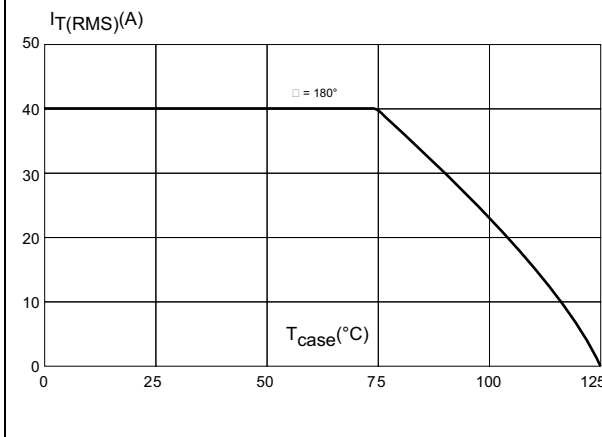

Figure 4. Relative variation of thermal impedance versus pulse duration

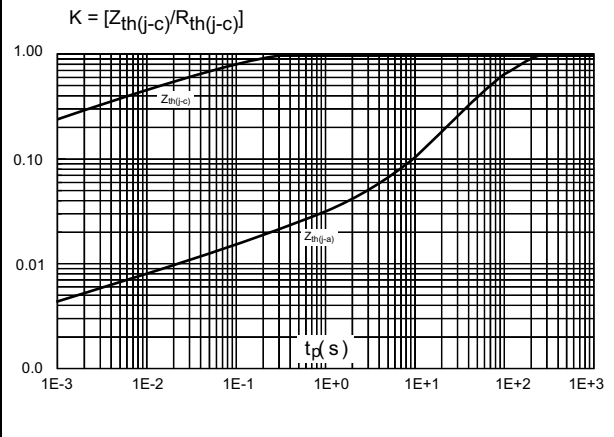

Figure 5. Relative variation of gate trigger current and holding current versus junction temperature

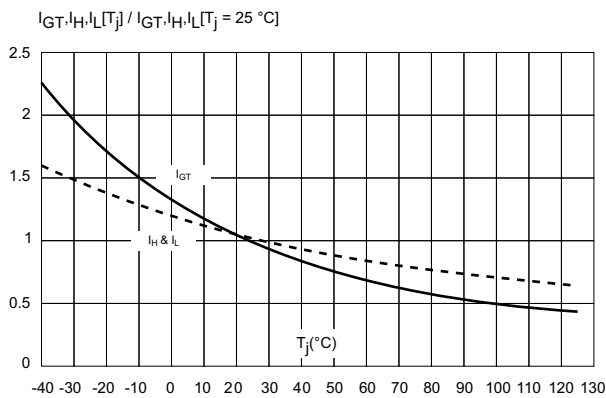

Figure 6. Non repetitive surge peak on-state current versus number of cycles

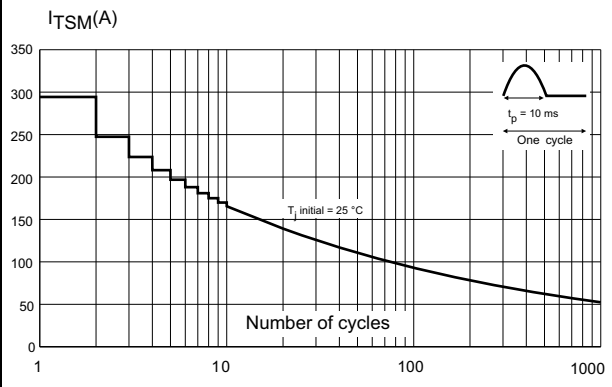

Figure 7. Non-repetitive surge peak on-state current for a sinusoidal pulse and corresponding values of I²t

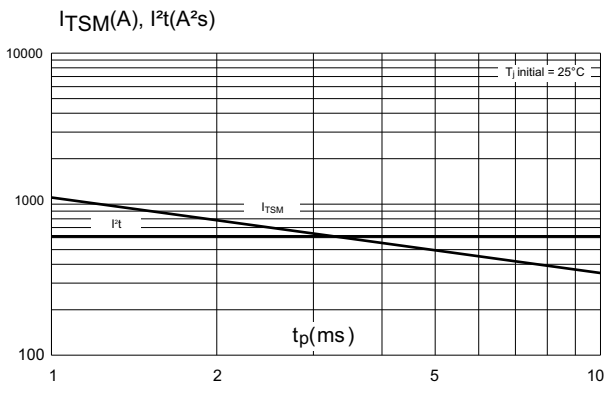

Figure 8. On-state characteristics (maximum values)

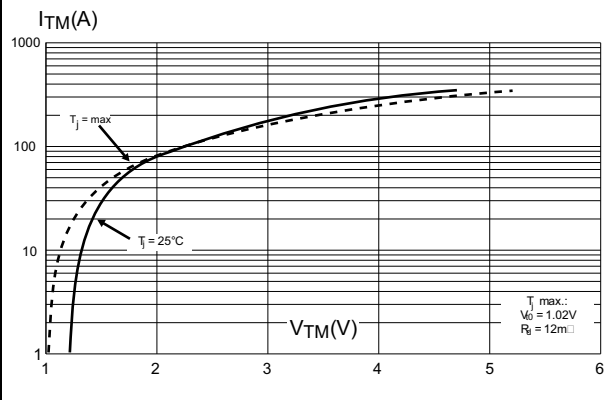
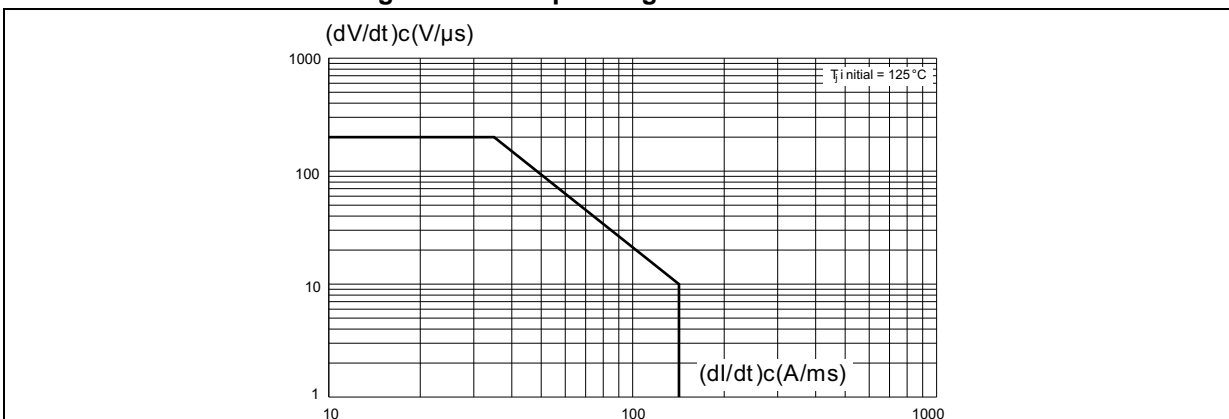

Figure 9. Safe operating area below curve



2 Package information

- Epoxy meets UL94, V0
- Cooling method:C (by conduction)
- Recommended torque value:0.9 to 1.2 N·m

In order to meet environmental requirements, ST offers these devices in different grades of ECOPACK[®] packages, depending on their level of environmental compliance. ECOPACK[®] specifications, grade definitions and product status are available at: www.st.com. ECOPACK[®] is an ST trademark.

2.1 TOP3 insulated package information

Figure 10. TOP3 insulated package outline

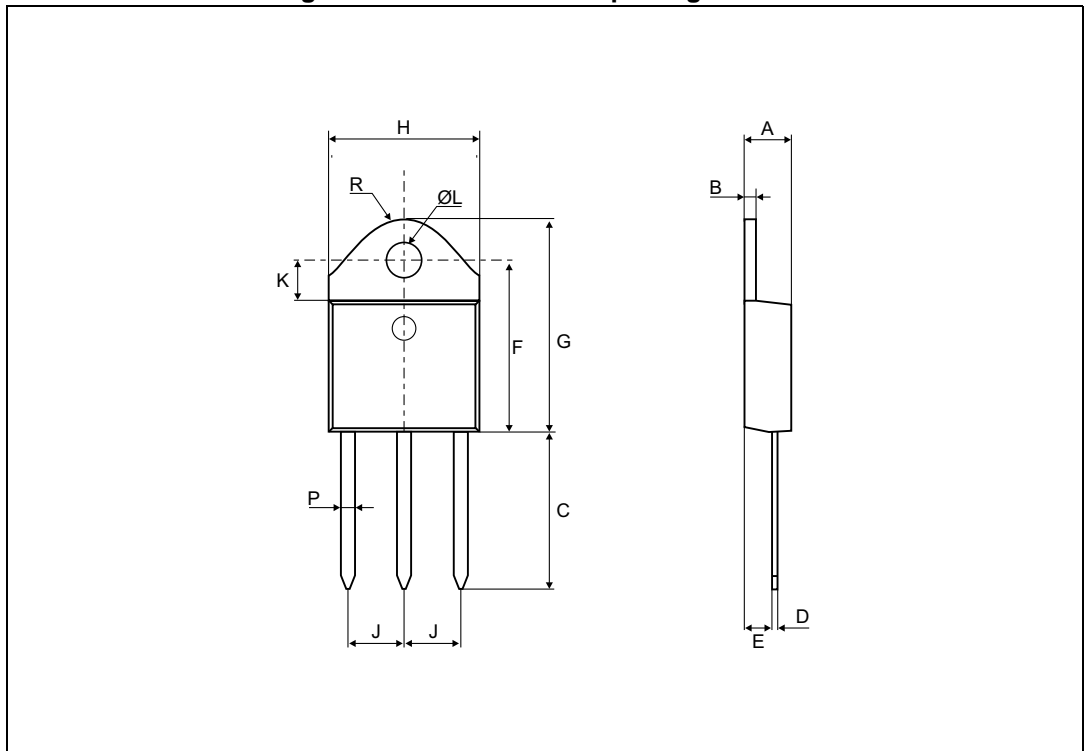

Table 6. TOP3 insulated package mechanical data

Ref.	Dimensions					
	Millimeters			Inches ⁽¹⁾		
	Typ.	Min.	Max.	Typ.	Min.	Max.
A		4.4	4.6		0.173	0.181
B		1.45	1.55		0.057	0.061
C		14.35	15.60		0.565	0.614
D		0.5	0.7		0.020	0.028
E		2.7	2.9		0.106	0.114
F		15.8	16.5		0.622	0.650
G		20.4	21.1		0.815	0.831
H		15.1	15.5		0.594	0.610
J		5.4	5.65		0.213	0.222
K		3.4	3.65		0.134	0.144
ØL		4.08	4.17		0.161	0.164
P		1.20	1.40		0.047	0.055
R	4.60			0.181		

1. Values in inches are converted from mm and rounded to 4 decimal digits.

3 Ordering information

Table 7. Ordering information

Order code	Marking	Package	Weight	Base qty.	delivery mode
TPDV640RG	TPDV640	TOP3 insulated	4.5 g	30	Tube
TPDV840RG	TPDV840				
TPDV1240RG	TPDV1240				

4 Revision history

Table 8. Document revision history

Date	Revision	Changes
30-Mar-2011	1	Initial release.
10-Jun-2015	2	Updated Table 3 . Updated Figure 9 . Format updated to current standard.

IMPORTANT NOTICE – PLEASE READ CAREFULLY

STMicroelectronics NV and its subsidiaries ("ST") reserve the right to make changes, corrections, enhancements, modifications, and improvements to ST products and/or to this document at any time without notice. Purchasers should obtain the latest relevant information on ST products before placing orders. ST products are sold pursuant to ST's terms and conditions of sale in place at the time of order acknowledgement.

Purchasers are solely responsible for the choice, selection, and use of ST products and ST assumes no liability for application assistance or the design of Purchasers' products.

No license, express or implied, to any intellectual property right is granted by ST herein.

Resale of ST products with provisions different from the information set forth herein shall void any warranty granted by ST for such product.

ST and the ST logo are trademarks of ST. All other product or service names are the property of their respective owners.

Information in this document supersedes and replaces information previously supplied in any prior versions of this document.

© 2015 STMicroelectronics – All rights reserved

Mouser Electronics

Authorized Distributor

Click to View Pricing, Inventory, Delivery & Lifecycle Information:

[STMicroelectronics:](#)

[TPDV1240RG](#) [TPDV640RG](#) [TPDV840RG](#)