

Description

The TS512 device is a high-performance dual operational amplifier with frequency and phase compensation built into the chip. The internal phase compensation allows stable operation in voltage follower configurations in spite of its high gain bandwidth product.

The circuit presents very stable electrical characteristics over the entire supply voltage range and it is particularly intended for professional and telecom applications (such as active filtering).

Features

- Low input offset voltage: 500 μ V max. (A version)
- Low power consumption
- Short-circuit protection
- Low distortion, low noise
- High gain bandwidth product: 3 MHz
- High channel separation
- ESD protection 2 kV
- Macromodel included in this specification

Contents

1	Absolute maximum ratings and operating conditions	3
2	Schematic diagram	4
3	Electrical characteristics	5
4	Macromodel	11
4.1	Important notes concerning this macromodel	11
4.2	Macromodel code	11
5	Package information	14
6	Ordering information	16
7	Revision history	17

1 Absolute maximum ratings and operating conditions

Table 1. Absolute maximum ratings

Symbol	Parameter	Value	Unit
V_{CC}	Supply voltage	± 18	V
V_{in}	Input voltage	$\pm V_{CC}$	
V_{id}	Differential input voltage	$\pm(V_{CC} - 1)$	
R_{thja}	Thermal resistance junction-to-ambient ⁽¹⁾	125	°C/W
R_{thjc}	Thermal resistance junction-to-case ⁽¹⁾	40	°C/W
T_j	Junction temperature	+150	°C
T_{stg}	Storage temperature range	-65 to +150	°C
ESD	HBM: human body model ⁽²⁾	2	kV
	MM: machine model ⁽³⁾	200	V
	CDM: charged device model ⁽⁴⁾	1.5	kV

- Short-circuits can cause excessive heating and destructive dissipation. R_{th} are typical values.
- Human body model: a 100 pF capacitor is charged to the specified voltage, then discharged through a 1.5 k Ω resistor between two pins of the device. This is done for all couples of connected pin combinations while the other pins are floating.
- Machine model: a 200 pF capacitor is charged to the specified voltage, then discharged directly between two pins of the device with no external series resistor (internal resistor < 5 Ω). This is done for all couples of connected pin combinations while the other pins are floating.
- Charged device model: all pins and the package are charged together to the specified voltage and then discharged directly to ground through only one pin. This is done for all pins.

Table 2. Operating conditions

Symbol	Parameter	Value	Unit
V_{CC}	Supply voltage ⁽¹⁾	6 to 30V	V
V_{icm}	Common mode input voltage range	$V_{CC}-1.5$ to $V_{CC}+1.5$	V
T_{oper}	Operating free air temperature range	-40 to +125	°C

- Value with respect to V_{CC} - pin.

2 Schematic diagram

Figure 1. Schematic diagram (1/2 TS512)

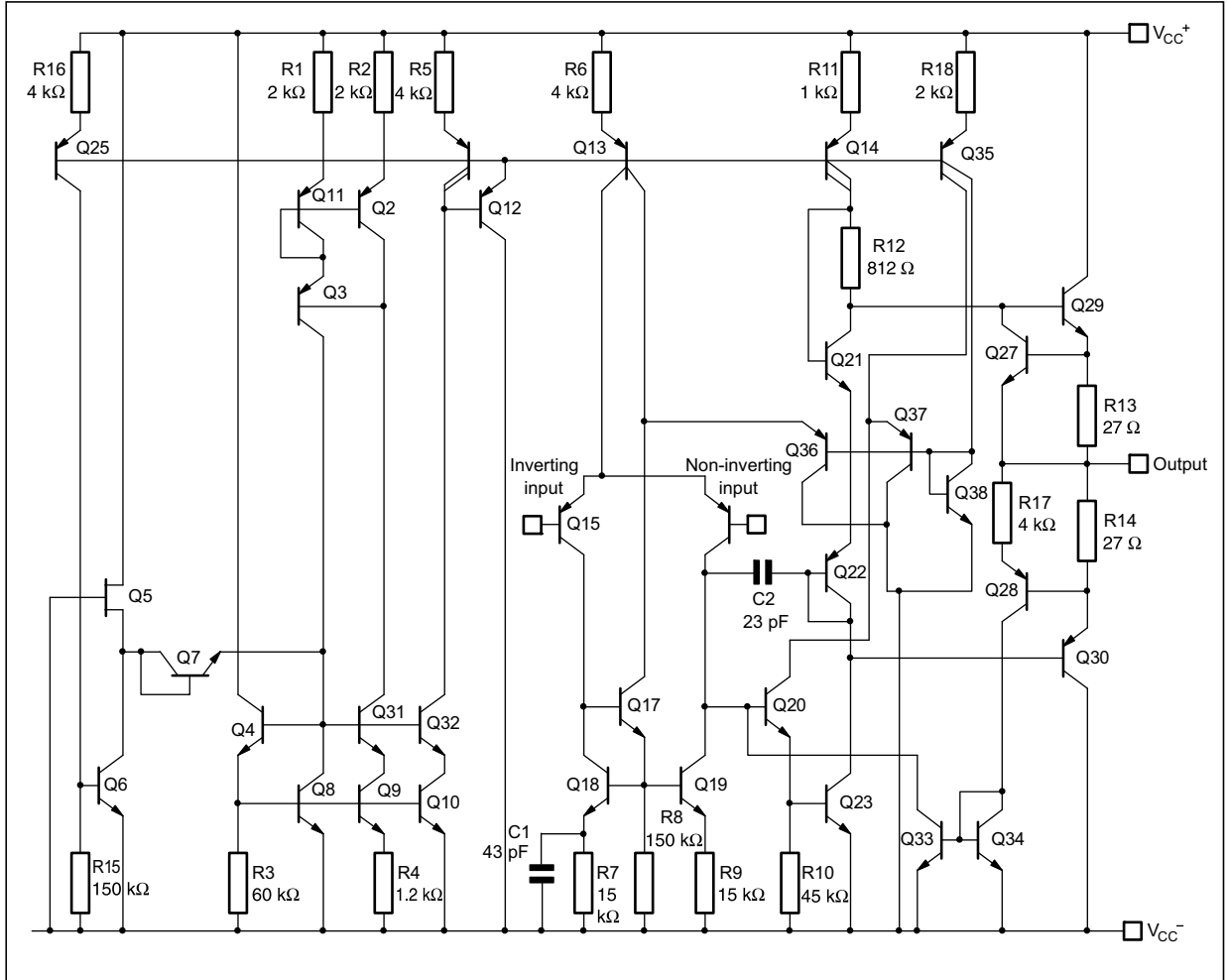

3 Electrical characteristics

Table 3. $V_{CC} = \pm 15\text{ V}$, $T_{amb} = 25\text{ }^\circ\text{C}$ (unless otherwise specified)

Symbol	Parameter	Min.	Typ.	Max.	Unit
I_{CC}	Supply current (per channel) $T_{min} \leq T_{amb} \leq T_{max}$		0.5	0.6 0.75	mA
I_{ib}	Input bias current $T_{min} \leq T_{amb} \leq T_{max}$		50	150 300	nA
R_{in}	Input resistance, $f = 1\text{ kHz}$		1		M Ω
V_{io}	Input offset voltage TS512 TS512A $T_{min} \leq T_{amb} \leq T_{max}$ TS512 TS512A		0.5	2.5 0.5 3.5 1.5	mV
ΔV_{io}	Input offset voltage drift $T_{min} \leq T_{amb} \leq T_{max}$		2		$\mu\text{V}/^\circ\text{C}$
I_{io}	Input offset current $T_{min} \leq T_{amb} \leq T_{max}$		5	20 40	nA
ΔI_{io}	Input offset current drift $T_{min} \leq T_{amb} \leq T_{max}$		0.08		nA/ $^\circ\text{C}$
I_{os}	Output short-circuit current		23		mA
A_{vd}	Large signal voltage gain $R_L = 2\text{ k}\Omega$, $V_{CC} = \pm 15\text{ V}$, $T_{min} \leq T_{amb} \leq T_{max}$ $V_{CC} = \pm 4\text{ V}$	90	100 95		dB
GBP	Gain bandwidth product, $f = 100\text{ kHz}$	1.8	3		MHz
e_n	Equivalent input noise voltage, $f = 1\text{ kHz}$ $R_s = 50\text{ }\Omega$ $R_s = 1\text{ k}\Omega$ $R_s = 10\text{ k}\Omega$		8 10 18		$\frac{\text{nV}}{\sqrt{\text{Hz}}}$
THD	Total harmonic distortion $A_v = 20\text{ dB}$, $R_L = 2\text{ k}\Omega$ $V_o = 2\text{ V}_{pp}$, $f = 1\text{ kHz}$		0.03		%
$\pm V_{opp}$	Output voltage swing $R_L = 2\text{ k}\Omega$, $V_{CC} = \pm 15\text{ V}$, $T_{min} \leq T_{amb} \leq T_{max}$ $V_{CC} = \pm 4\text{ V}$	± 13	± 3		V
V_{opp}	Large signal voltage swing $R_L = 10\text{ k}\Omega$, $f = 10\text{ kHz}$		28		V_{pp}
SR	Slew rate Unity gain, $R_L = 2\text{ k}\Omega$	0.8	1.5		V/ μs
CMR	Common mode rejection ratio $\text{CMR} = 20 \log (\Delta V_{ic}/\Delta V_{io})$ ($V_{ic} = -10\text{ V}$ to 10 V , $V_{out} = V_{CC}/2$, $R_L > 1\text{ M}\Omega$)	90			dB

Table 3. $V_{CC} = \pm 15\text{ V}$, $T_{amb} = 25\text{ °C}$ (unless otherwise specified) (continued)

Symbol	Parameter	Min.	Typ.	Max.	Unit
SVR	Supply voltage rejection ratio $20 \log (\Delta V_{CC} / \Delta V_{io})$ ($V_{CC} = \pm 4\text{ V}$ to $\pm 15\text{ V}$, $V_{out} = V_{icm} = V_{CC}/2$)	90			dB
V_{o1}/V_{o2}	Channel separation, $f = 1\text{ kHz}$		120		dB

Figure 2. V_{io} distribution at $V_{CC} = \pm 15\text{ V}$ and $T = 25\text{ }^\circ\text{C}$

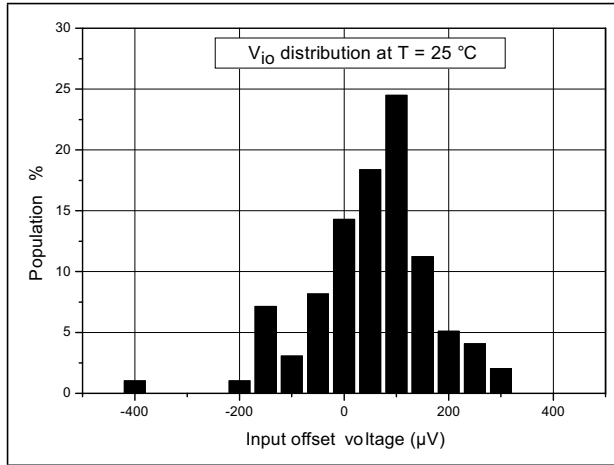

Figure 3. V_{io} distribution at $V_{CC} = \pm 15\text{ V}$ and $T = 125\text{ }^\circ\text{C}$

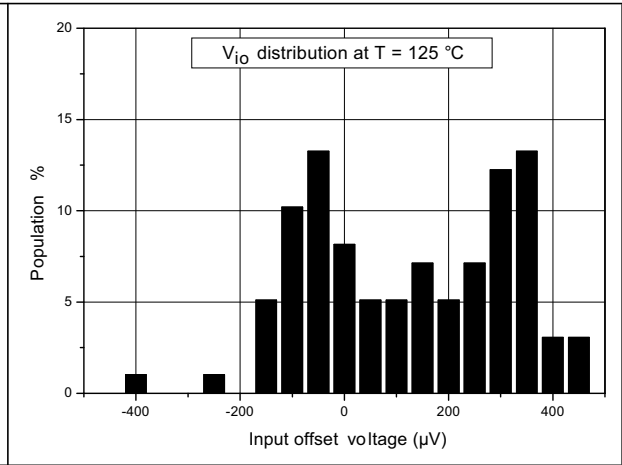

Figure 4. Input offset voltage vs. input common mode voltage at $V_{CC} = 10\text{ V}$

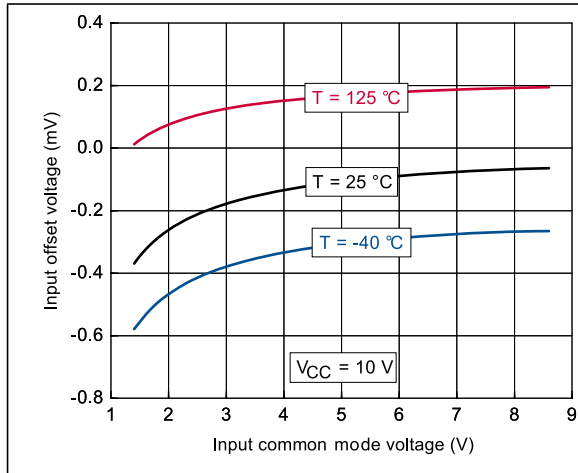

Figure 5. Input offset voltage vs. input common mode voltage at $V_{CC} = 30\text{ V}$

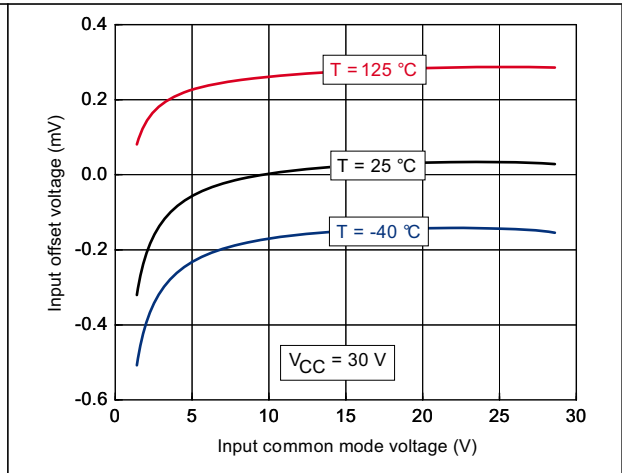

Figure 6. Supply current (per channel) vs. supply voltage at $V_{icm} = V_{CC}/2$

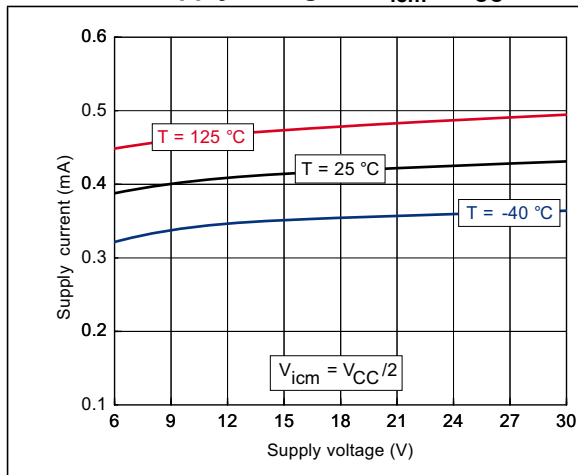

Figure 7. Supply current (per channel) vs. input common mode voltage at $V_{CC} = 6\text{ V}$

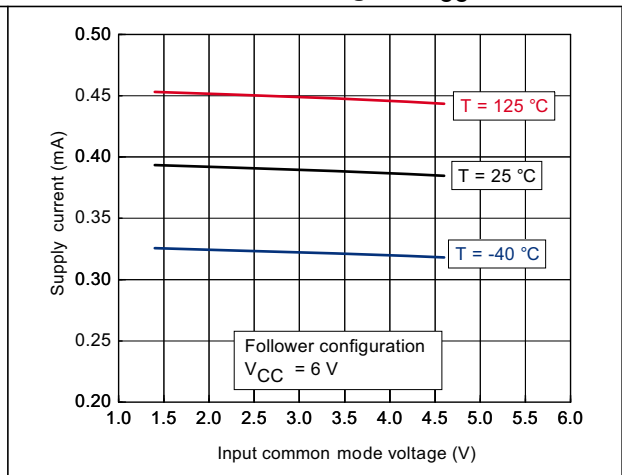

Figure 8. Supply current (per channel) vs. input common mode voltage at $V_{CC} = 10\text{ V}$

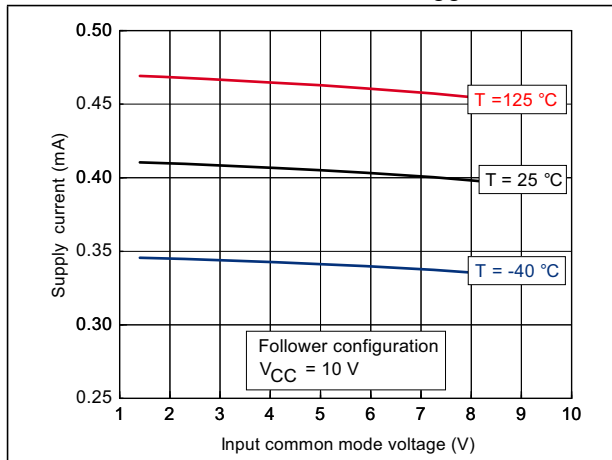

Figure 9. Supply current (per channel) vs. input common mode voltage at $V_{CC} = 30\text{ V}$

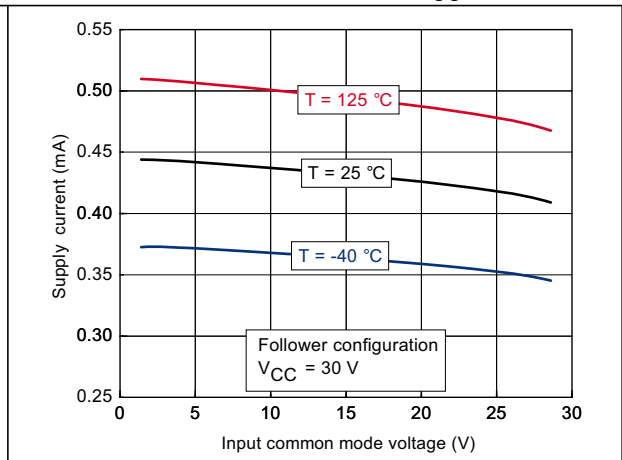

Figure 10. Output current vs. supply voltage at $V_{icm} = V_{CC}/2$

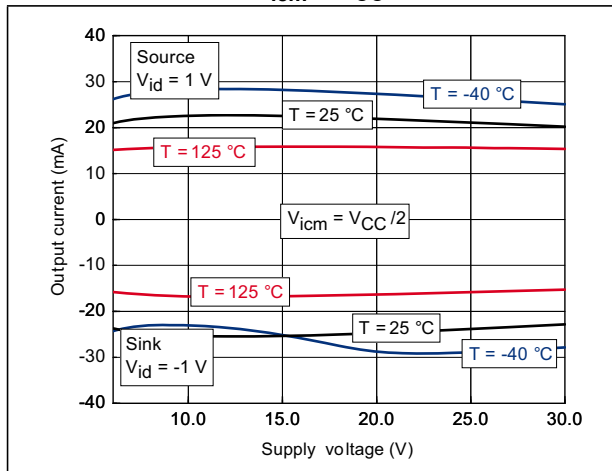

Figure 11. Output current vs. output voltage at $V_{CC} = 5\text{ V}$

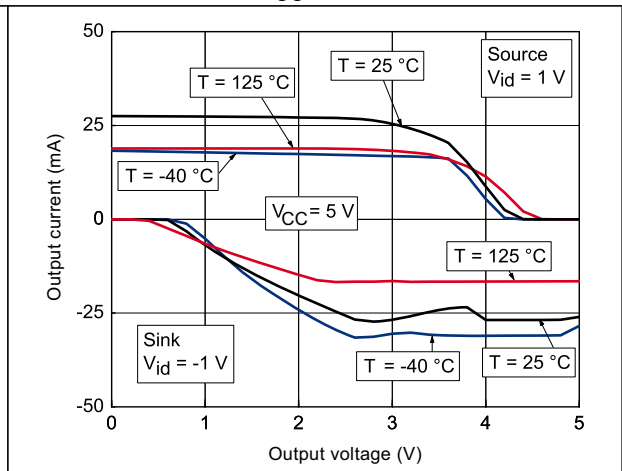

Figure 12. Output current vs. output voltage at $V_{CC} = 30\text{ V}$

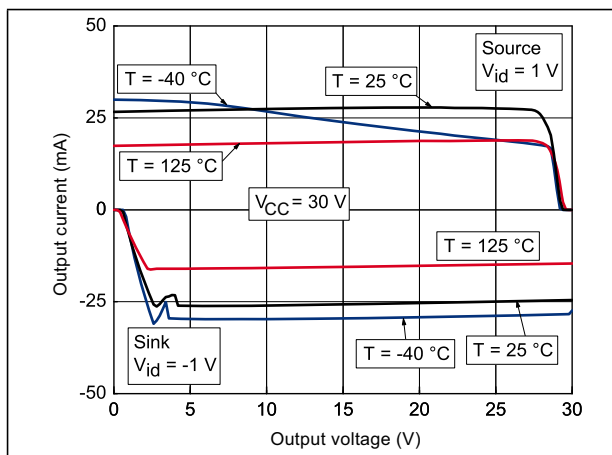

Figure 13. Voltage gain and phase for different capacitive loads at $V_{CC} = 6\text{ V}$, $V_{icm} = 3\text{ V}$ and $T = 25\text{ °C}$

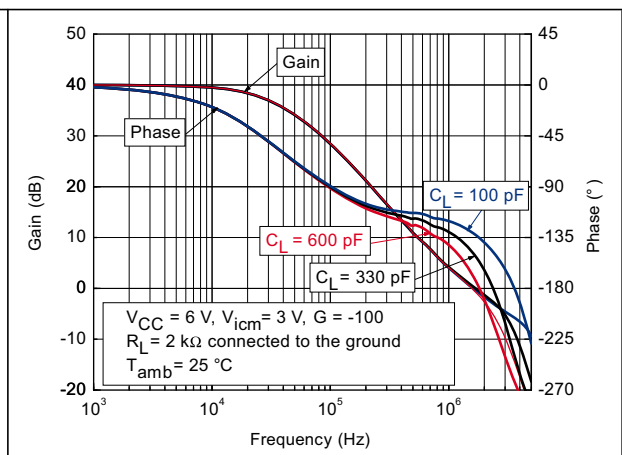

Figure 14. Voltage gain and phase for different capacitive loads at $V_{CC} = 10\text{ V}$, $V_{icm} = 5\text{ V}$ and $T = 25\text{ }^\circ\text{C}$

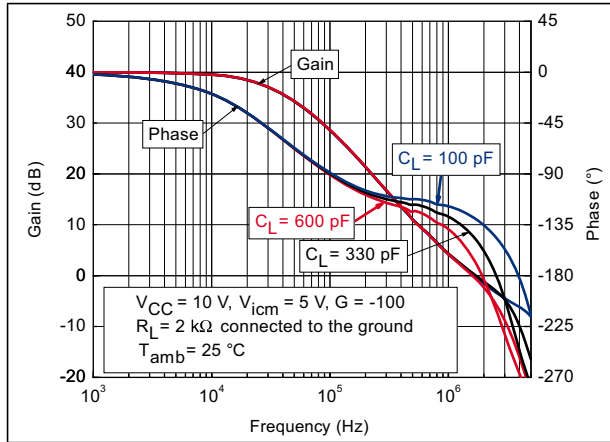

Figure 15. Voltage gain and phase for different capacitive loads at $V_{CC} = 30\text{ V}$, $V_{icm} = 15\text{ V}$ and $T = 25\text{ }^\circ\text{C}$

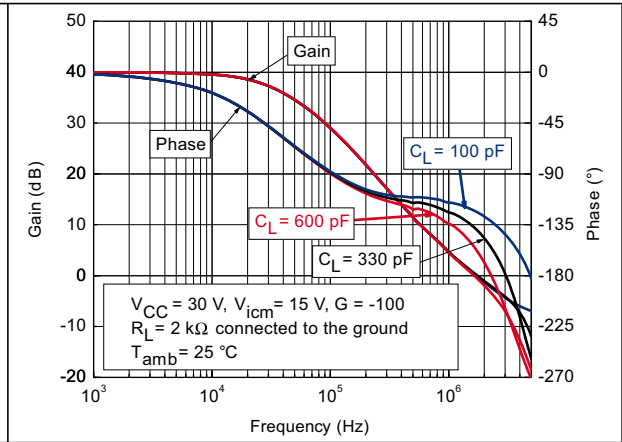

Figure 16. Frequency response for different capacitive loads at $V_{CC} = 6\text{ V}$, $V_{icm} = 3\text{ V}$ and $T = 25\text{ }^\circ\text{C}$

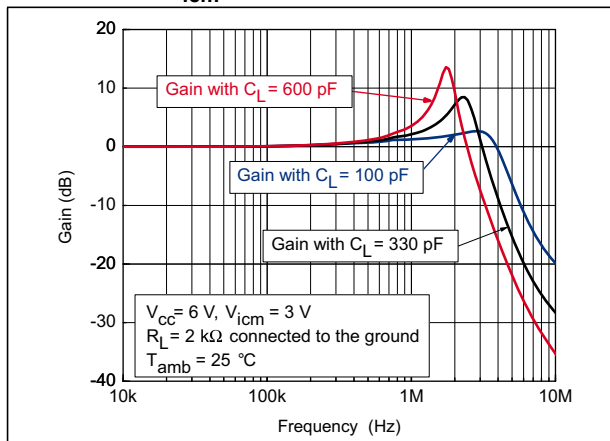

Figure 17. Frequency response for different capacitive loads at $V_{CC} = 10\text{ V}$, $V_{icm} = 5\text{ V}$ and $T = 25\text{ }^\circ\text{C}$

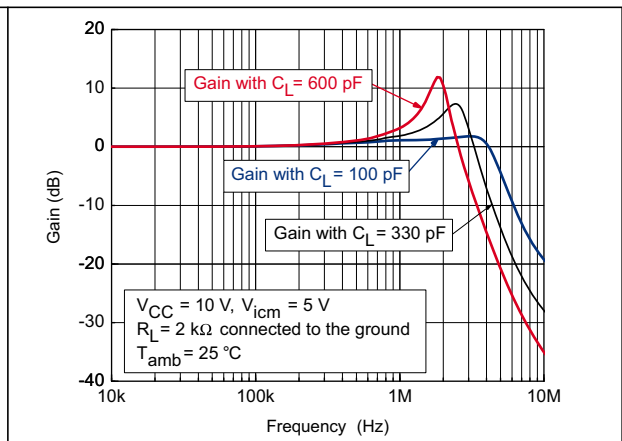

Figure 18. Frequency response for different capacitive loads at $V_{CC} = 30\text{ V}$, $V_{icm} = 15\text{ V}$ and $T = 25\text{ }^\circ\text{C}$

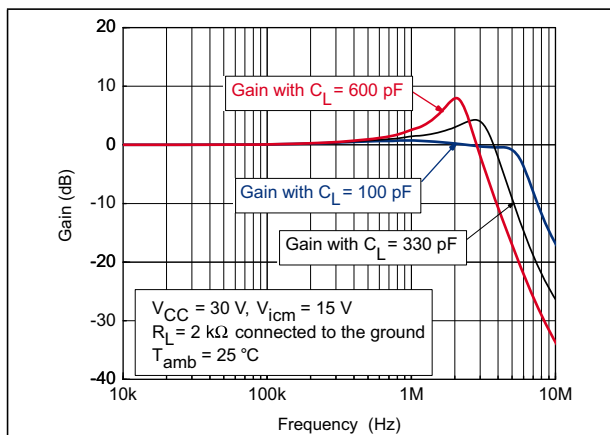

Figure 19. Phase margin vs. output current, at $V_{CC} = 6\text{ V}$, $V_{icm} = 3\text{ V}$ and $T = 25\text{ }^\circ\text{C}$

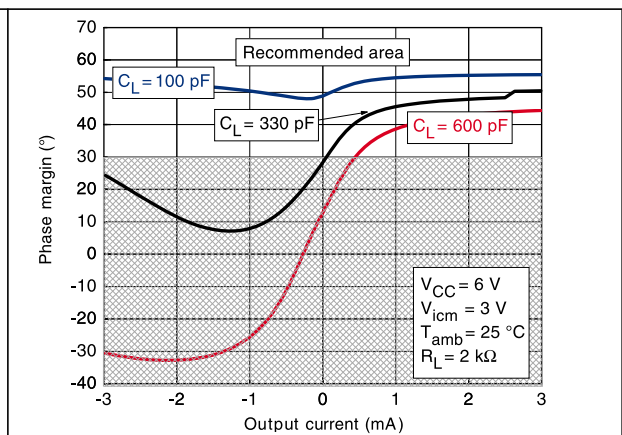

Figure 20. Phase margin vs. output current, at $V_{CC} = 10\text{ V}$, $V_{icm} = 5\text{ V}$ and $T = 25\text{ }^\circ\text{C}$

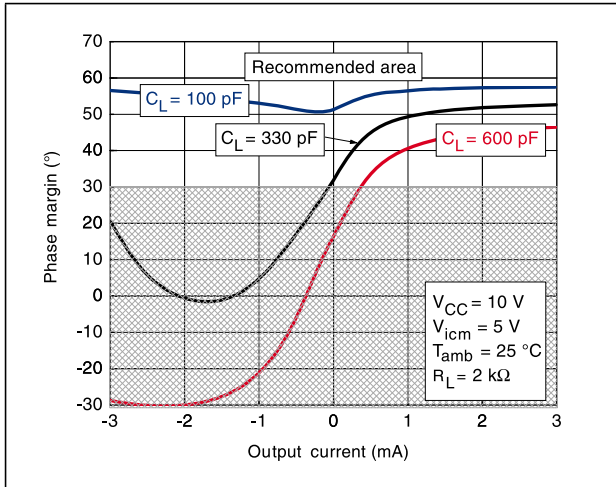
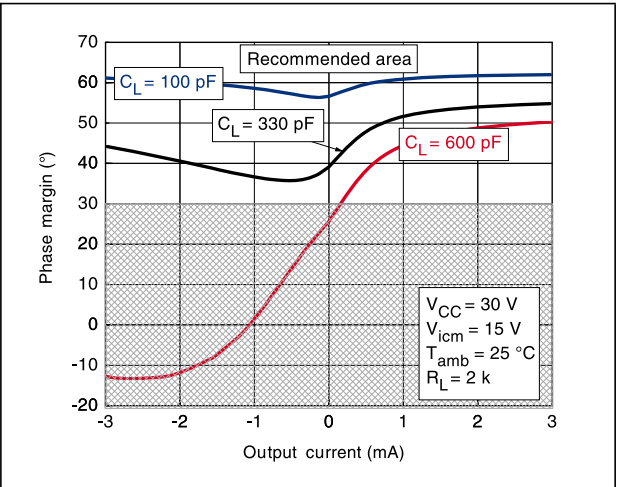

Figure 21. Phase margin vs. output current, at $V_{CC} = 30\text{ V}$, $V_{icm} = 15\text{ V}$ and $T = 25\text{ }^\circ\text{C}$



4 Macromodel

4.1 Important notes concerning this macromodel

- All models are a trade-off between accuracy and complexity (i.e. simulation time).
- Macromodels are not a substitute to breadboarding; rather, they confirm the validity of a design approach and help to select surrounding component values.
- A macromodel emulates the **nominal** performance of a **typical** device within **specified operating conditions** (temperature, supply voltage, for example). Thus the macromodel is often not as exhaustive as the datasheet, its purpose is to illustrate the main parameters of the product.

Data derived from macromodels used outside of the specified conditions (V_{CC} , temperature, for example) or even worse, outside of the device operating conditions (V_{CC} , V_{icm} , for example), is not reliable in any way.

4.2 Macromodel code

```

** Standard Linear Ics Macromodels, 1993.
** CONNECTIONS :
* 1 INVERTING INPUT
* 2 NON-INVERTING INPUT
* 3 OUTPUT
* 4 POSITIVE POWER SUPPLY
* 5 NEGATIVE POWER SUPPLY

.SUBCKT TS512 1 3 2 4 5
*****
.MODEL MDTH D IS=1E-8 KF=6.565195E-17 CJO=10F
* INPUT STAGE
CIP 2 5 1.000000E-12
CIN 1 5 1.000000E-12
EIP 10 5 2 5 1
EIN 16 5 1 5 1
RIP 10 11 2.600000E+01
RIN 15 16 2.600000E+01
RIS 11 15 1.061852E+02
DIP 11 12 MDTH 400E-12
DIN 15 14 MDTH 400E-12
VOFP 12 13 DC 0
VOFN 13 14 DC 0
IPOL 13 5 1.000000E-05
CPS 11 15 12.47E-10
DINN 17 13 MDTH 400E-12
VIN 17 5 1.500000e+00
DINR 15 18 MDTH 400E-12

```

```
VIP 4 18 1.500000E+00
FCP 4 5 VAFP 3.400000E+01
FCN 5 4 VAFN 3.400000E+01
FIBP 2 5 VAFN 1.000000E-02
FIBN 5 1 VAFP 1.000000E-02
* AMPLIFYING STAGE
FIP 5 19 VAFP 9.000000E+02
FIN 5 19 VAFN 9.000000E+02
RG1 19 5 1.727221E+06
RG2 19 4 1.727221E+06
CC 19 5 6.000000E-09
DOPM 19 22 MDTH 400E-12
DONM 21 19 MDTH 400E-12
HOPM 22 28 VOUT 6.521739E+03
VIPM 28 4 1.500000E+02
HONM 21 27 VOUT 6.521739E+03
VINM 5 27 1.500000E+02
GCOMP 5 4 4 5 6.485084E-04
RPM1 5 80 1E+06
RPM2 4 80 1E+06
GAVPH 5 82 19 80 2.59E-03
RAVPHGH 82 4 771
RAVPHGB 82 5 771
RAVPHDH 82 83 1000
RAVPHDB 82 84 1000
CAVPHH 4 83 0.331E-09
CAVPHB 5 84 0.331E-09
EOUT 26 23 82 5 1
VOUT 23 5 0
ROUT 26 3 6.498455E+01
COUT 3 5 1.000000E-12
DOP 19 25 MDTH 400E-12
VOP 4 25 1.742230E+00
DON 24 19 MDTH 400E-12
VON 24 5 1.742230E+00
.ENDS
```

Table 4. $V_{CC} = \pm 15\text{ V}$, $T_{amb} = 25\text{ }^\circ\text{C}$ (unless otherwise specified)

Symbol	Conditions	Value	Unit
V_{io}		0	mV
A_{vd}	$R_L = 2\text{ k}\Omega$	100	V/mV
I_{CC}	No load, per channel	350	μA
V_{icm}		-13.4 to 14	V
V_{OH}	$R_L = 2\text{ k}\Omega$	+14	V
V_{OL}	$R_L = 2\text{ k}\Omega$	-14	V
I_{sink}	$V_o = 0\text{ V}$	27.5	mA
I_{source}	$V_o = 0\text{ V}$	27.5	mA
GBP	$R_L = 2\text{ k}\Omega$, $C_L = 100\text{ pF}$	2.5	MHz
SR	$R_L = 2\text{ k}\Omega$	1.4	V/ μs
$\varnothing m$	$R_L = 2\text{ k}\Omega$, $C_L = 100\text{ pF}$	55	Degrees

5 Package information

In order to meet environmental requirements, ST offers these devices in different grades of ECOPACK® packages, depending on their level of environmental compliance. ECOPACK specifications, grade definitions and product status are available at: www.st.com. ECOPACK is an ST trademark.

Figure 22. SO-8 package outline

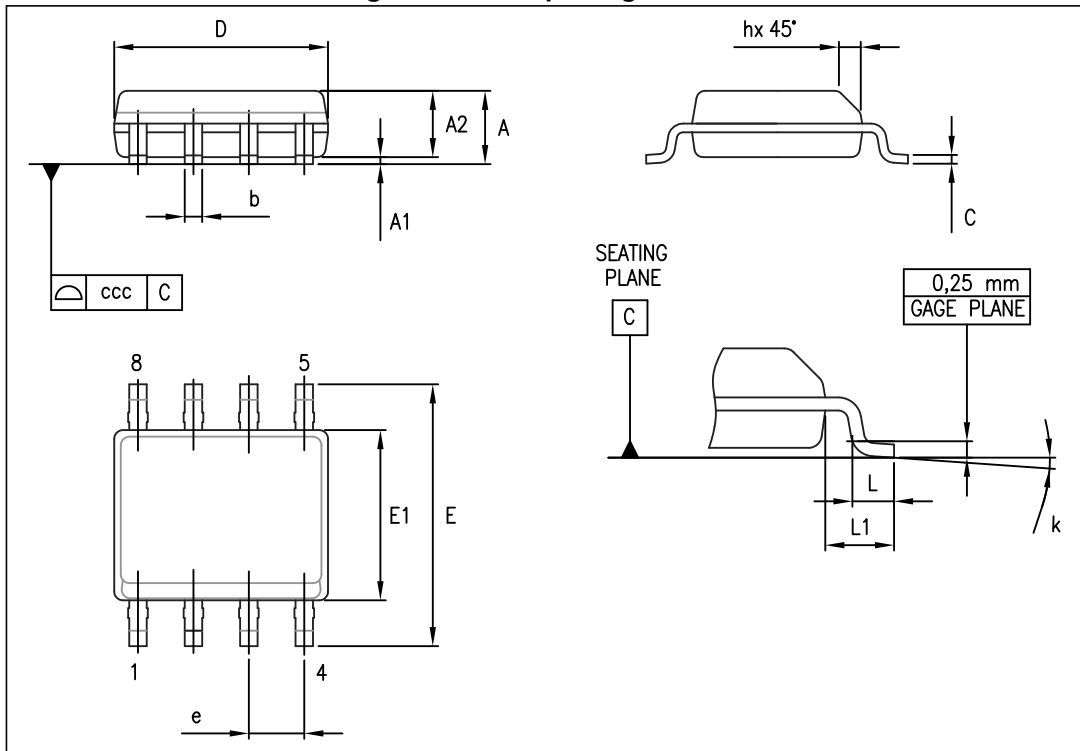

Table 5. SO-8 package mechanical data

Symbol	Dimensions					
	Millimeters			Inches		
	Min.	Typ.	Max.	Min.	Typ.	Max.
A			1.75			0.069
A1	0.10		0.25	0.004		0.010
A2	1.25			0.049		
b	0.28		0.48	0.011		0.019
c	0.17		0.23	0.007		0.010
D	4.80	4.90	5.00	0.189	0.193	0.197
E	5.80	6.00	6.20	0.228	0.236	0.244
E1	3.80	3.90	4.00	0.150	0.154	0.157
e		1.27			0.050	
h	0.25		0.50	0.010		0.020
L	0.40		1.27	0.016		0.050
L1		1.04			0.040	
k	0		8°	1°		8°
ccc			0.10			0.004

6 Ordering information

Table 6. Order codes

Order code	Temperature range	Package	Packaging	Marking
TS512IDT	-40 °C, + 125 °C	SO-8	Tape and reel	512I
TS512AIDT				512AI
TS512IYDT ⁽¹⁾		SO-8 (automotive grade)	Tape and reel	512IY
TS512AIYDT ⁽¹⁾				512AIY

1. Qualification and characterization according to AEC Q100 and Q003 or equivalent, advanced screening according to AEC Q001 and Q002 or equivalent.

7 Revision history

Table 7. Document revision history

Date	Revision	Changes
21-Nov-2001	1	Initial release.
23-Jun-2005	2	PPAP references inserted in the datasheet, see Table 6: Order codes .
05-May-2008	3	AC and DC performance characteristics curves added for $V_{CC} = 6V$, $V_{CC} = 10V$ and $V_{CC} = 30V$. Modified I_{CC} typ, added parameters over temperature range in electrical characteristics table. Corrected macromodel information.
04-Feb-2010	4	Updated document format. Added TS512A and related parameters. Modified footnote 1 under Table 2 . Removed Figure 11 . Modified Figure 12 and Figure 13 . Removed TS512AIYD order code from Table 6 .
12-Sep-2012	5	Updated CMR and SVR test conditions in Table 3 . Removed TS512IYD order code from Table 6 . Minor corrections throughout document.
20-Mar-2014	6	Removed DIP8 package option Removed shipping option in tubes from Table 6: Order codes Updated footnote 1 of Table 6: Order codes Minor textual updates

Please Read Carefully:

Information in this document is provided solely in connection with ST products. STMicroelectronics NV and its subsidiaries ("ST") reserve the right to make changes, corrections, modifications or improvements, to this document, and the products and services described herein at any time, without notice.

All ST products are sold pursuant to ST's terms and conditions of sale.

Purchasers are solely responsible for the choice, selection and use of the ST products and services described herein, and ST assumes no liability whatsoever relating to the choice, selection or use of the ST products and services described herein.

No license, express or implied, by estoppel or otherwise, to any intellectual property rights is granted under this document. If any part of this document refers to any third party products or services it shall not be deemed a license grant by ST for the use of such third party products or services, or any intellectual property contained therein or considered as a warranty covering the use in any manner whatsoever of such third party products or services or any intellectual property contained therein.

UNLESS OTHERWISE SET FORTH IN ST'S TERMS AND CONDITIONS OF SALE ST DISCLAIMS ANY EXPRESS OR IMPLIED WARRANTY WITH RESPECT TO THE USE AND/OR SALE OF ST PRODUCTS INCLUDING WITHOUT LIMITATION IMPLIED WARRANTIES OF MERCHANTABILITY, FITNESS FOR A PARTICULAR PURPOSE (AND THEIR EQUIVALENTS UNDER THE LAWS OF ANY JURISDICTION), OR INFRINGEMENT OF ANY PATENT, COPYRIGHT OR OTHER INTELLECTUAL PROPERTY RIGHT.

ST PRODUCTS ARE NOT DESIGNED OR AUTHORIZED FOR USE IN: (A) SAFETY CRITICAL APPLICATIONS SUCH AS LIFE SUPPORTING, ACTIVE IMPLANTED DEVICES OR SYSTEMS WITH PRODUCT FUNCTIONAL SAFETY REQUIREMENTS; (B) AERONAUTIC APPLICATIONS; (C) AUTOMOTIVE APPLICATIONS OR ENVIRONMENTS, AND/OR (D) AEROSPACE APPLICATIONS OR ENVIRONMENTS. WHERE ST PRODUCTS ARE NOT DESIGNED FOR SUCH USE, THE PURCHASER SHALL USE PRODUCTS AT PURCHASER'S SOLE RISK, EVEN IF ST HAS BEEN INFORMED IN WRITING OF SUCH USAGE, UNLESS A PRODUCT IS EXPRESSLY DESIGNATED BY ST AS BEING INTENDED FOR "AUTOMOTIVE, AUTOMOTIVE SAFETY OR MEDICAL" INDUSTRY DOMAINS ACCORDING TO ST PRODUCT DESIGN SPECIFICATIONS. PRODUCTS FORMALLY ESCC, QML OR JAN QUALIFIED ARE DEEMED SUITABLE FOR USE IN AEROSPACE BY THE CORRESPONDING GOVERNMENTAL AGENCY.

Resale of ST products with provisions different from the statements and/or technical features set forth in this document shall immediately void any warranty granted by ST for the ST product or service described herein and shall not create or extend in any manner whatsoever, any liability of ST.

ST and the ST logo are trademarks or registered trademarks of ST in various countries.

Information in this document supersedes and replaces all information previously supplied.

The ST logo is a registered trademark of STMicroelectronics. All other names are the property of their respective owners.

© 2014 STMicroelectronics - All rights reserved

STMicroelectronics group of companies

Australia - Belgium - Brazil - Canada - China - Czech Republic - Finland - France - Germany - Hong Kong - India - Israel - Italy - Japan - Malaysia - Malta - Morocco - Philippines - Singapore - Spain - Sweden - Switzerland - United Kingdom - United States of America

www.st.com

Mouser Electronics

Authorized Distributor

Click to View Pricing, Inventory, Delivery & Lifecycle Information:

[STMicroelectronics:](#)

[TS512AID](#) [TS512AIN](#) [TS512AIDT](#) [TS512IDT](#) [TS512ID](#) [TS512IN](#) [TS512IYDT](#) [TS512AIYDT](#)