



N-Channel 20-V (D-S) MOSFET

PRODUCT SUMMARY		
V_{DS} (V)	$r_{DS(on)}$ (Ω)	I_D (A)
20	0.033 @ $V_{GS} = 4.5$ V	4.9
	0.040 @ $V_{GS} = 2.5$ V	4.4
	0.051 @ $V_{GS} = 1.8$ V	3.9

FEATURES

- TrenchFET® Power MOSFET
- ESD Protected: 3000 V
- RoHS Compliant



Pb-free
Available

APPLICATIONS

- LI-Ion Battery Protection

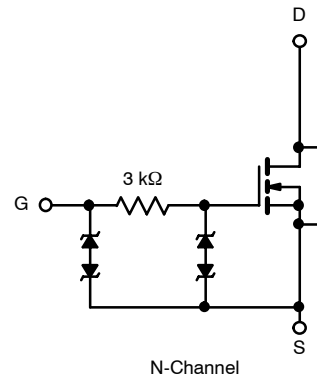
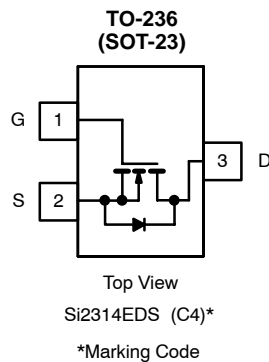

Ordering Information: Si2314EDS-T1
Si2314EDS-T1—E3 (Lead (Pb)-Free)

ABSOLUTE MAXIMUM RATINGS ($T_A = 25^\circ\text{C}$ UNLESS OTHERWISE NOTED)					
Parameter	Symbol	5 sec	Steady State	Unit	
Drain-Source Voltage	V_{DS}	20		V	
Gate-Source Voltage	V_{GS}	± 12			
Continuous Drain Current ($T_J = 150^\circ\text{C}$) ^a	I_D	$T_A = 25^\circ\text{C}$	4.9	3.77	A
		$T_A = 70^\circ\text{C}$	3.9	3.0	
Pulsed Drain Current ^b	I_{DM}	15			
Avalanche Current ^b	I_{AS}	15			
Single Avalanche Energy	E_{AS}	11.25		mJ	
Continuous Source Current (Diode Conduction) ^a	I_S	1.0		A	
Power Dissipation ^a	P_D	$T_A = 25^\circ\text{C}$	1.25	0.75	W
		$T_A = 70^\circ\text{C}$	0.80	0.48	
Operating Junction and Storage Temperature Range	T_J, T_{stg}	-55 to 150		$^\circ\text{C}$	

THERMAL RESISTANCE RATINGS					
Parameter	Symbol	Typical	Maximum	Unit	
Maximum Junction-to-Ambient ^a	R_{thJA}	$t \leq 5$ sec	75	100	$^\circ\text{C/W}$
		Steady State	120	166	
Maximum Junction-to-Foot	R_{thJF}	40	50		

Notes

- Surface Mounted on 1" x 1" FR4 Board.
- Pulse width limited by maximum junction temperature



SPECIFICATIONS (T_A = 25 °C UNLESS OTHERWISE NOTED)						
Parameter	Symbol	Test Conditions	Limits			Unit
			Min	Typ	Max	
Static						
Drain-Source Breakdown Voltage	V _{(BR)DSS}	V _{GS} = 0 V, I _D = 250 μA	20			V
Gate-Threshold Voltage	V _{GS(th)}	V _{DS} = V _{GS} , I _D = 250 μA	0.45		0.95	
Gate-Body Leakage	I _{GSS}	V _{DS} = 0 V, V _{GS} = ±4.5 V			±1.5	μA
Zero Gate Voltage Drain Current	I _{DSS}	V _{DS} = 20 V, V _{GS} = 0 V			1	
		V _{DS} = 20 V, V _{GS} = 0 V, T _J = 70 °C			75	
On-State Drain Current ^a	I _{D(on)}	V _{DS} ≥ 10 V, V _{GS} = 4.5 V	15			A
Drain-Source On-Resistance ^a	r _{DS(on)}	V _{GS} = 4.5 V, I _D = 5.0 A		0.027	0.033	Ω
		V _{GS} = 2.5 V, I _D = 4.5 A		0.033	0.040	
		V _{GS} = 1.8 V, I _D = 4.0 A		0.042	0.051	
Forward Transconductance ^a	g _{fs}	V _{DS} = 15 V, I _D = 5.0 A		40		S
Diode Forward Voltage	V _{SD}	I _S = 1.0 A, V _{GS} = 0 V		0.8	1.2	V
Dynamic^b						
Total Gate Charge	Q _g	V _{DS} = 10 V, V _{GS} = 4.5 V, I _D = 5.0 A		11.0	14.0	nC
Gate-Source Charge	Q _{gs}			1.5		
Gate-Drain Charge	Q _{gd}			2.1		
Switching						
Turn-On Delay Time	t _{d(on)}	V _{DD} = 10 V, R _L = 10 Ω I _D ≅ 1.0 A, V _{GEN} = 4.5 V, R _g = 6 Ω		0.53	0.8	μs
Rise Time	t _r			1.4	2.2	
Turn-Off Delay Time	t _{d(off)}			13.5	20	
Fall-Time	t _f			5.9	9	
Source-Drain Reverse Recovery Time	t _{rr}	I _F = 1.0 A, di/dt = 100 A/μs		13	25	ns

Notes

- a. Pulse test: PW ≤ 300 μs duty cycle ≤ 2%.
- b. Guaranteed by design, not subject to production testing.

Stresses beyond those listed under "Absolute Maximum Ratings" may cause permanent damage to the device. These are stress ratings only, and functional operation of the device at these or any other conditions beyond those indicated in the operational sections of the specifications is not implied. Exposure to absolute maximum rating conditions for extended periods may affect device reliability.

TYPICAL CHARACTERISTICS (25 °C UNLESS NOTED)

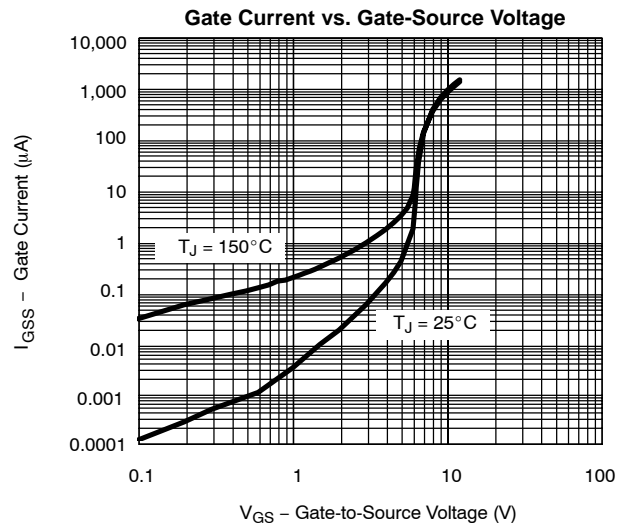
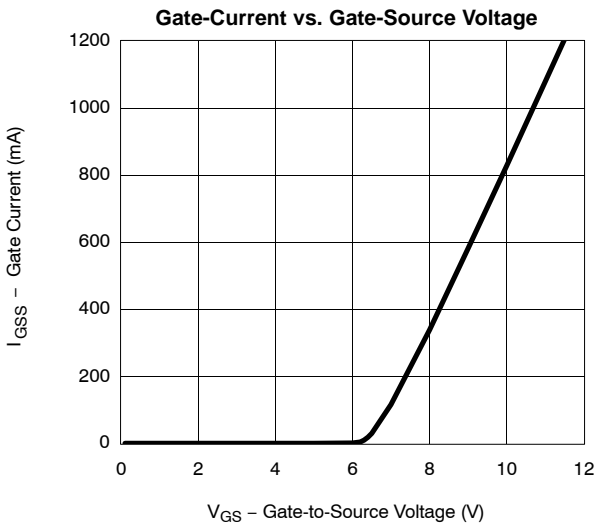



TYPICAL CHARACTERISTICS (25°C UNLESS NOTED)

Output Characteristics

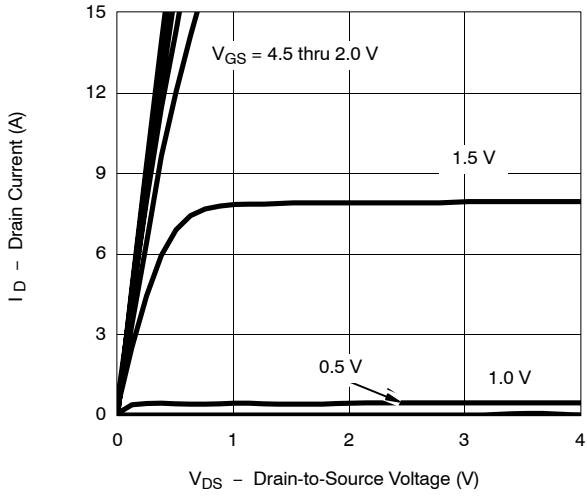

Transfer Characteristics

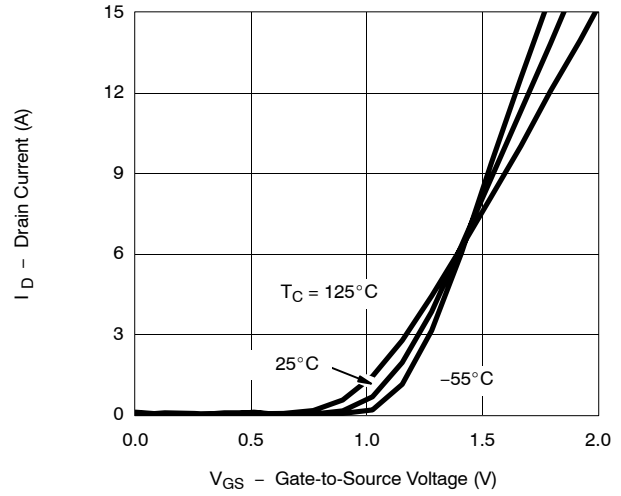

On-Resistance vs. Drain Current

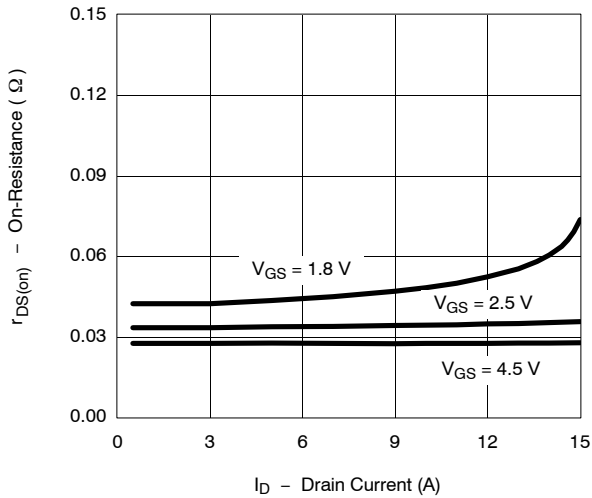

Capacitance

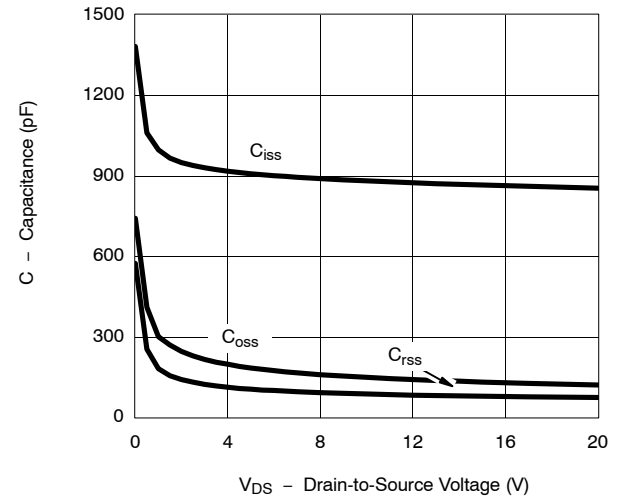

Gate Charge

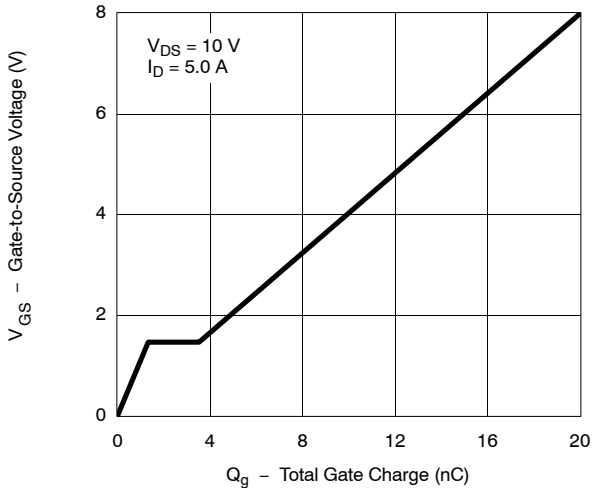

On-Resistance vs. Junction Temperature

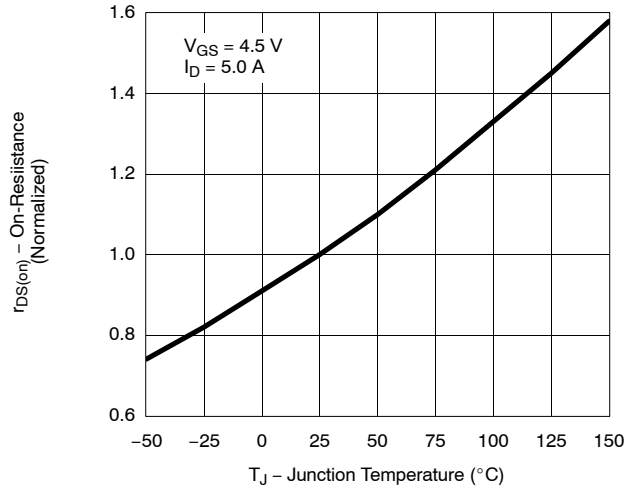

TYPICAL CHARACTERISTICS (25°C UNLESS NOTED)

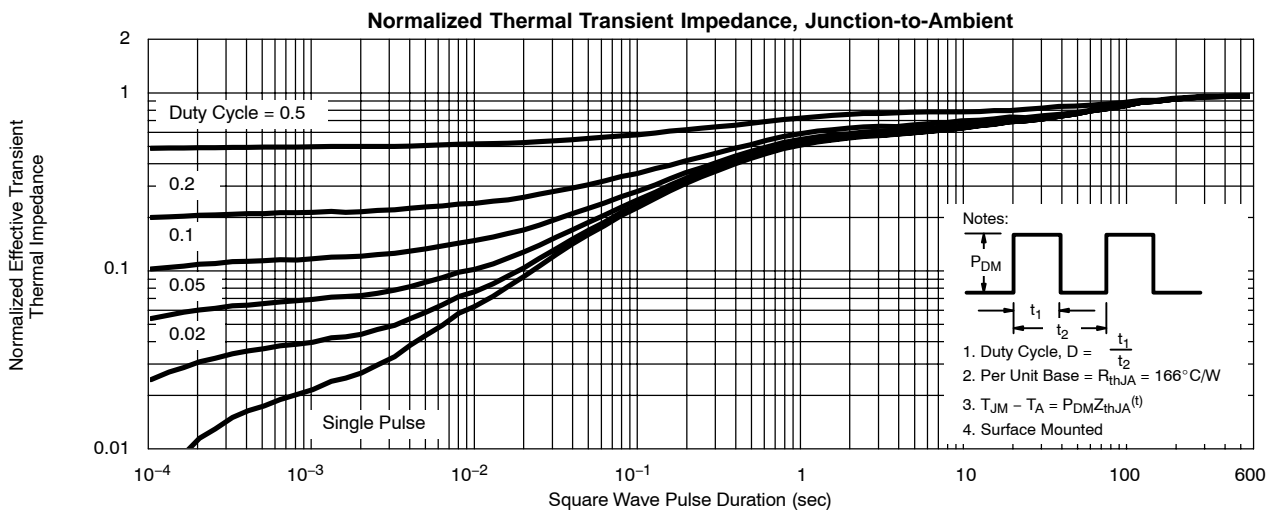
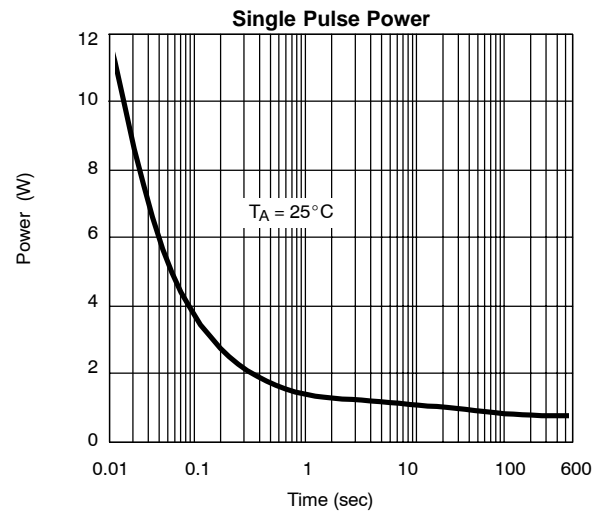
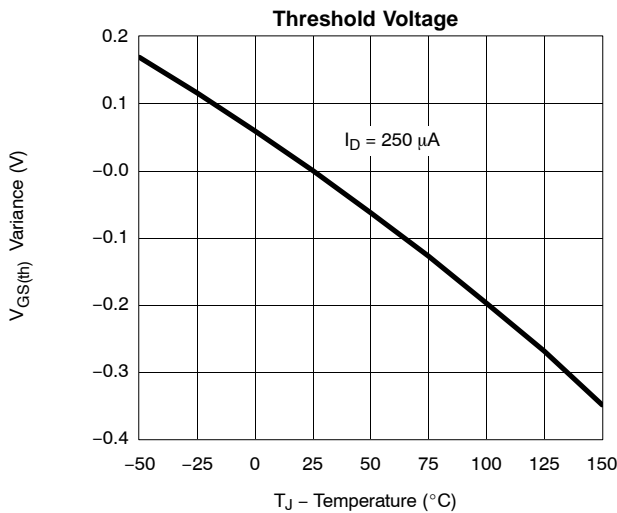
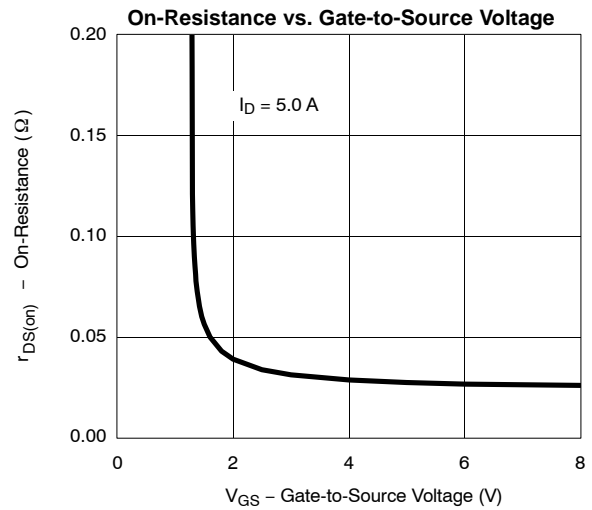
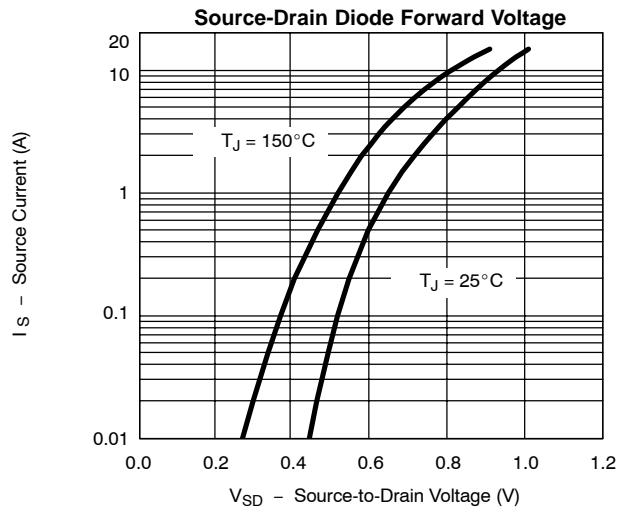

Vishay Siliconix maintains worldwide manufacturing capability. Products may be manufactured at one of several qualified locations. Reliability data for Silicon Technology and Package Reliability represent a composite of all qualified locations. For related documents such as package/tape drawings, part marking, and reliability data, see <http://www.vishay.com/ppg?71611>.



Notice

Specifications of the products displayed herein are subject to change without notice. Vishay Intertechnology, Inc., or anyone on its behalf, assumes no responsibility or liability for any errors or inaccuracies.

Information contained herein is intended to provide a product description only. No license, express or implied, by estoppel or otherwise, to any intellectual property rights is granted by this document. Except as provided in Vishay's terms and conditions of sale for such products, Vishay assumes no liability whatsoever, and disclaims any express or implied warranty, relating to sale and/or use of Vishay products including liability or warranties relating to fitness for a particular purpose, merchantability, or infringement of any patent, copyright, or other intellectual property right.

The products shown herein are not designed for use in medical, life-saving, or life-sustaining applications. Customers using or selling these products for use in such applications do so at their own risk and agree to fully indemnify Vishay for any damages resulting from such improper use or sale.

Mouser Electronics

Authorized Distributor

Click to View Pricing, Inventory, Delivery & Lifecycle Information:

[Vishay:](#)

[SI2314EDS-T1](#) [SI2314EDS-T1-E3](#)