

Optocoupler, Phototransistor Output, Dual Channel, SOIC-8 package, 110 °C Rated

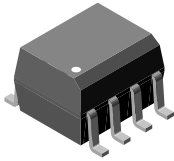
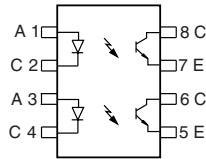

1179018

FEATURES

- Operating temperature from - 55 °C to + 110 °C
- Two Channel Coupler
- SOIC-8 Surface Mountable Package
- Isolation Test Voltage, 4000 V_{RMS}
- Compatible with Dual Wave, Vapor Phase and IR Reflow Soldering
- Lead (Pb)-free component
- Component in accordance to RoHS 2002/95/EC and WEEE 2002/96/EC

RoHS
COMPLIANT

DESCRIPTION

The 110 °C rated ILD1205T/1206T/1207T are optically coupled pairs with a Gallium Arsenide infrared LED and a silicon NPN phototransistor. Signal information, including a DC level, can be transmitted by the device while maintaining a high degree of electrical isolation between input and output. The ILD1205T/1206T/1207T come in a standard SOIC-8 small outline package for surface mounting which makes it ideally suited for high density applications with limited space. In addition to eliminating through-holes requirements, this package conforms to standards for surface mounted devices.

A specified minimum and maximum CTR allows a narrow tolerance in the electrical design of the adjacent circuits. The high BV_{CEO} of 70 V gives a higher safety margin compared to the industry standard of 30 V.

AGENCY APPROVALS

- UL - File No. E52744 System Code Y
- CUL - File No. E52744, equivalent to CSA bulletin 5A
- DIN EN 60747-5-2(VDE0884)
Available with Option 1

APPLICATIONS

- AC Adapters
- PLCs
- Switch Mode Power Supplies
- DC/DC Converters
- Microprocessor I/O Interfaces
- General impedance matching circuits

ORDER INFORMATION

PART	REMARKS
ILD1205T	CTR 40 - 80 %, SOIC-8
ILD1206T	CTR 63 - 125 %, SOIC-8
ILD1207T	CTR 100 - 200 %, SOIC-8

Note:

For additional information on the available options refer to Option Information.

ABSOLUTE MAXIMUM RATINGS¹⁾				
PARAMETER	TEST CONDITION	SYMBOL	VALUE	UNIT
INPUT				
Continuous forward current per channel		I_F	30	mA
Peak reverse voltage		V_R	6.0	V
Peak pulsed current	1.0 μ s, 300 pps	I_{FSM}	1.0	A
Power dissipation		P_{diss}	50	mW
Derate linearly from 25 °C			0.5	mW/°C
OUTPUT				
Collector-emitter voltage		V_{CE}	70	V
Power dissipation per channel		P_{diss}	125	mW
Derate linearly from 25 °C			1.25	mW/°C
COUPLER				
Isolation test voltage	t = 1.0 s	V_{ISO}	4000	V_{RMS}
Operating temperature		T_{amb}	- 55 to + 110	°C
Total package dissipation ambient (2 LEDs + 2 detectors, 2 channels)		P_{tot}	300	mW
Derate linearly from 25 °C			4.0	mW/°C
Storage temperature		T_{stg}	- 55 to + 150	°C

Note:

¹⁾ $T_{amb} = 25$ °C, unless otherwise specified.

Stresses in excess of the absolute Maximum Ratings can cause permanent damage to the device. Functional operation of the device is not implied at these or any other conditions in excess of those given in the operational sections of this document. Exposure to absolute Maximum Rating for extended periods of the time can adversely affect reliability.

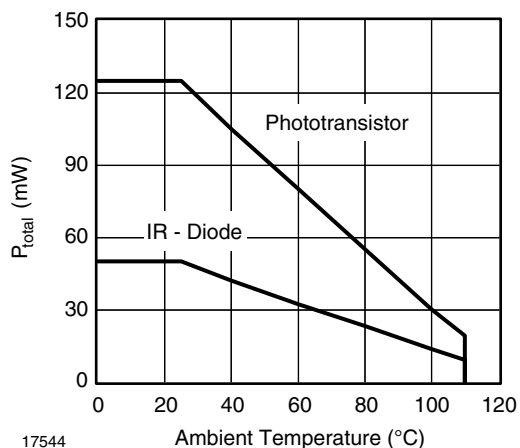

17544
Figure 1. Power Dissipation vs. Ambient Temperature

ELECTRICAL CHARACTERISTICS ¹⁾							
PARAMETER	TEST CONDITION	PART	SYMBOL	MIN	TYP.	MAX	UNIT
INPUT							
Forward voltage	$I_F = 10 \text{ mA}$		V_F		1.2	1.55	V
Reverse current	$V_R = 6.0 \text{ V}$		I_R		0.1	100	μA
Capacitance	$V_R = 0$		C_I		25		pF
OUTPUT							
Collector-emitter leakage current	$V_{CE} = 10 \text{ V}, I_F = 0$		I_{CEO}		5.0	50	nA
Collector-emitter breakdown voltage	$I_C = 100 \mu\text{A}$		BV_{CEO}	70			V
Emitter-collector breakdown voltage	$I_E = 10 \mu\text{A}$		BV_{ECO}	7.0			V
Collector-emitter saturation voltage	$I_F = 10 \text{ mA}, I_C = 2.5 \text{ mA}$		V_{CEsat}			0.4	V
Collector-emitter capacitance	$V_{CE} = 0$		C_{CE}		10		pF
COUPLER							
DC Current Transfer Ratio	$V_{CE} = 5.0 \text{ V}, I_F = 10 \text{ mA}$	ILD1205T	CTR	40		80	%
		ILD1206T	CTR	63		125	%
		ILD1207T	CTR	100		200	%
Capacitance (input-output)			C_{IO}		0.5		pF

Note:

¹⁾ $T_{amb} = 25 \text{ }^\circ\text{C}$, unless otherwise specified.

Minimum and maximum values are testing requirements. Typical values are characteristics of the device and are the result of engineering evaluation. Typical values are for information only and are not part of the testing requirements.

SWITCHING CHARACTERISTICS							
PARAMETER	TEST CONDITION	PART	SYMBOL	MIN.	TYPE	MAX	UNIT
Turn-on time	$I_C = 2.0 \text{ mA}, R_L = 100 \Omega,$ $V_{CC} = 5.0 \text{ V}$		t_{on}	5.0			μs
Turn-off time	$I_C = 2.0 \text{ mA}, R_L = 100 \Omega,$ $V_{CC} = 5.0 \text{ V}$		t_{off}	4.0			μs

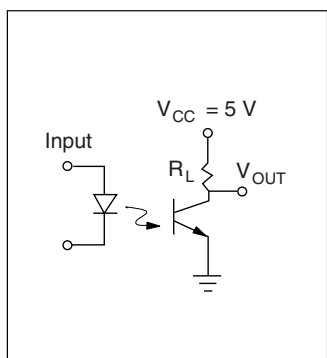

iiid205t_08

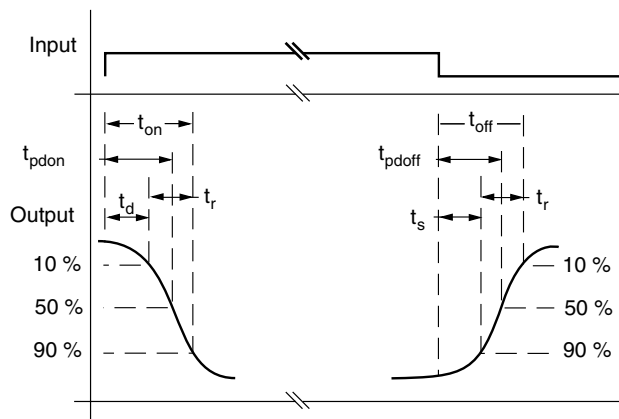

Figure 2. Switching Test Circuit

SAFETY AND INSULATION RATINGS ¹⁾							
PARAMETER	TEST CONDITION	PART	SYMBOL	MIN.	TYPE	MAX.	UNIT
Climatic Classification (according to IEC 68 part 1)					55/110/21		
Polution Degree (DIN VDE 0109)					2.0		mm
Comparative tracking index per DIN IEC112/VDE 0303 part 1, group IIIa per DIN VDE 6110 175 399				175		399	
V_{IOTM}			V_{IOTM}	6000			V
V_{IORM}			V_{IORM}	560			V
Resistance, input to output			R_{IO}		100		Ω
P_{SI}						350	mW
I_{SI}						150	mA
T_{SI}						165	$^{\circ}C$
Creeepage				4.0			mm
Clearance				4.0			mm

Note:

¹⁾ As per IEC60747-5-2, §7.4.3.8.1, this optocoupler is suitable for "safe electrical insulation" only within the safety ratings. Compliance with the safety ratings shall be ensured by means of protective circuits.

TYPICAL CHARACTERISTICS

$T_{amb} = 25^{\circ}C$, unless otherwise specified

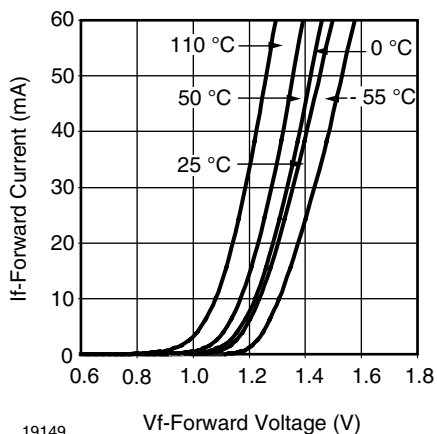

19149 Figure 3. Forward Current vs. Forward Voltage

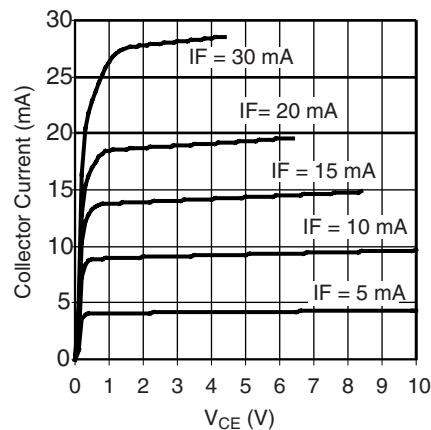

Figure 4. V_{CE} vs. I_C , (Non-Saturated)

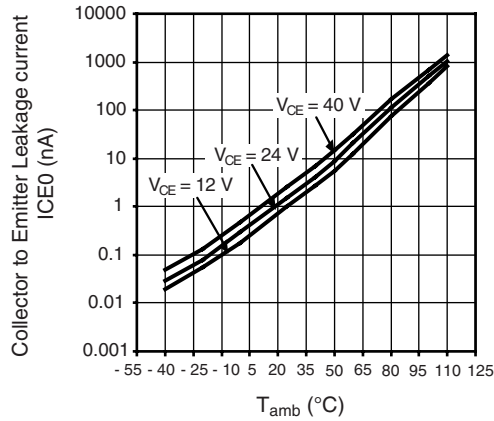
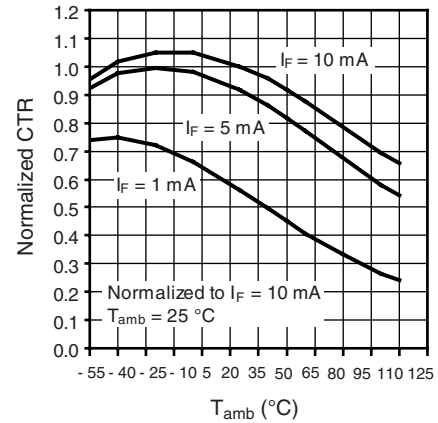

Figure 5. Collector to Emitter Leakage Current vs. Ambient Temperature



Normalized CTR vs. Ambient Temperature (Non-Saturated, $V_{CE} = 5 V$)

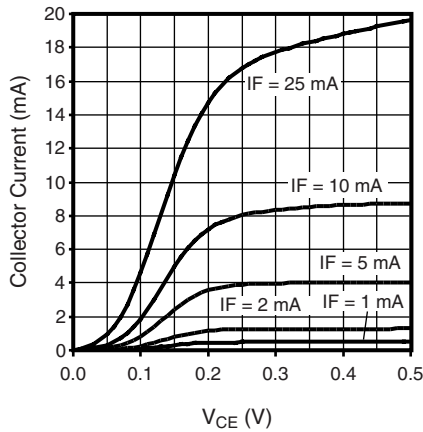

Figure 6. V_{CE} vs. I_C (Saturated)

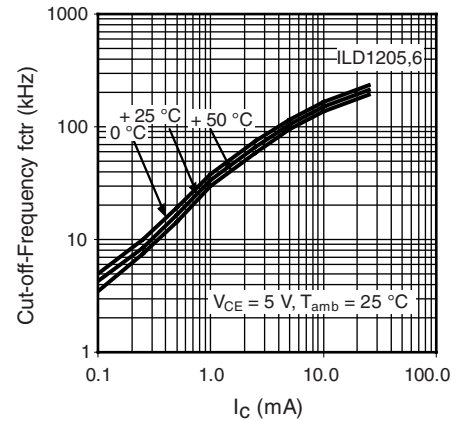

Figure 8. Cut-off-Frequency (- 3 dB) vs. Collector Current

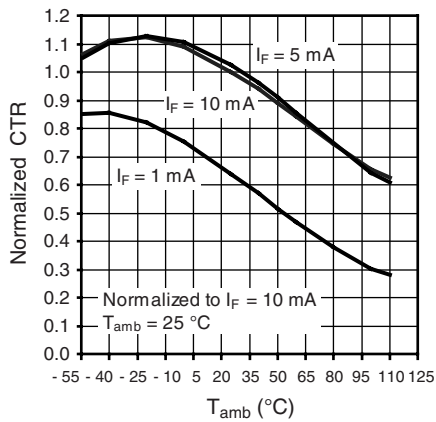

Figure 7. Normalized CTR vs. Ambient Temperature (Saturated, $V_{CE} = 0.4 V$)

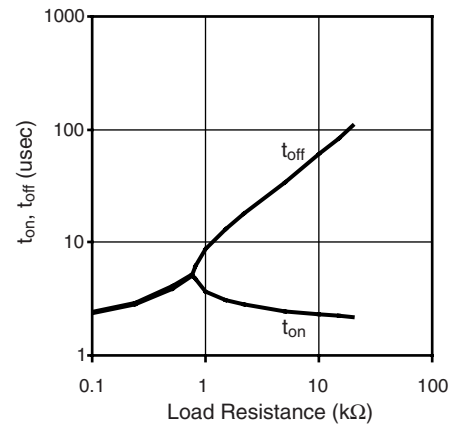

Figure 9. t_{on} , t_{off} vs. Load Resistance (100 Ω to 20000 Ω)

ILD1205T/1206T/1207T

Vishay Semiconductors



PACKAGE DIMENSIONS in inches (millimeters)

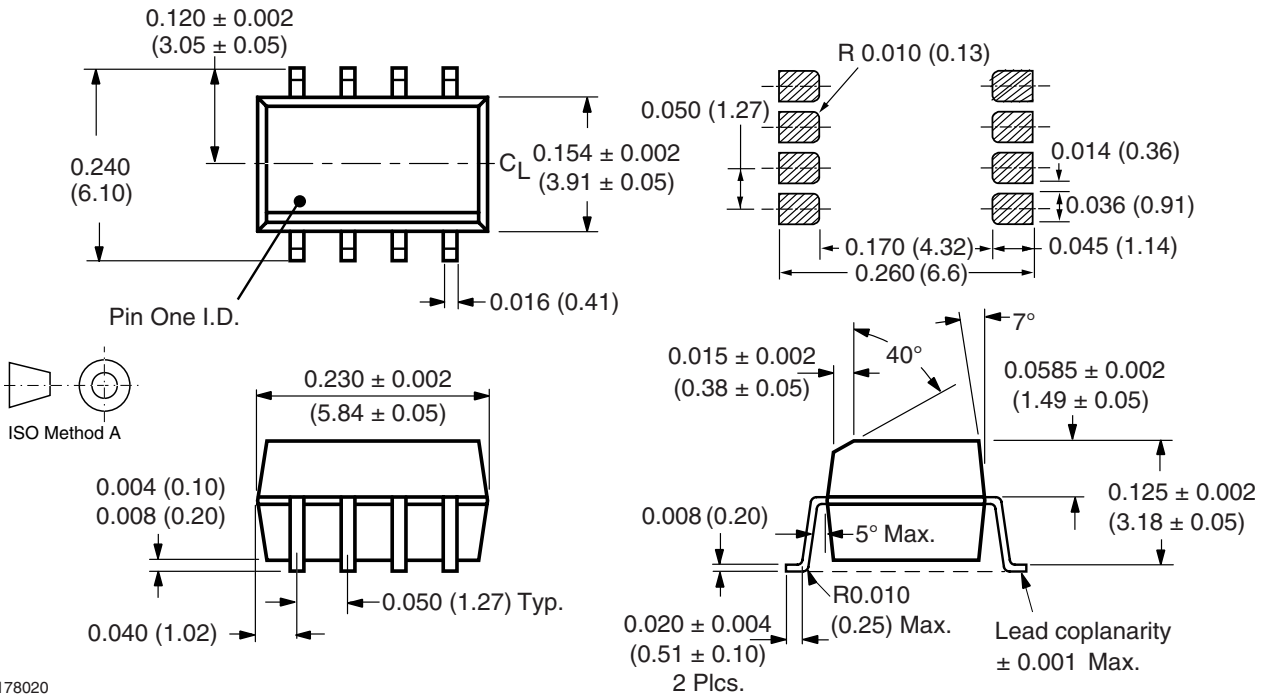



OZONE DEPLETING SUBSTANCES POLICY STATEMENT

It is the policy of Vishay Semiconductor GmbH to

1. Meet all present and future national and international statutory requirements.
2. Regularly and continuously improve the performance of our products, processes, distribution and operating systems with respect to their impact on the health and safety of our employees and the public, as well as their impact on the environment.

It is particular concern to control or eliminate releases of those substances into the atmosphere which are known as ozone depleting substances (ODSs).

The Montreal Protocol (1987) and its London Amendments (1990) intend to severely restrict the use of ODSs and forbid their use within the next ten years. Various national and international initiatives are pressing for an earlier ban on these substances.

Vishay Semiconductor GmbH has been able to use its policy of continuous improvements to eliminate the use of ODSs listed in the following documents.

1. Annex A, B and list of transitional substances of the Montreal Protocol and the London Amendments respectively
2. Class I and II ozone depleting substances in the Clean Air Act Amendments of 1990 by the Environmental Protection Agency (EPA) in the USA
3. Council Decision 88/540/EEC and 91/690/EEC Annex A, B and C (transitional substances) respectively.

Vishay Semiconductor GmbH can certify that our semiconductors are not manufactured with ozone depleting substances and do not contain such substances.

We reserve the right to make changes to improve technical design and may do so without further notice.

Parameters can vary in different applications. All operating parameters must be validated for each customer application by the customer. Should the buyer use Vishay Semiconductors products for any unintended or unauthorized application, the buyer shall indemnify Vishay Semiconductors against all claims, costs, damages, and expenses, arising out of, directly or indirectly, any claim of personal damage, injury or death associated with such unintended or unauthorized use.

Vishay Semiconductor GmbH, P.O.B. 3535, D-74025 Heilbronn, Germany



Disclaimer

All product specifications and data are subject to change without notice.

Vishay Intertechnology, Inc., its affiliates, agents, and employees, and all persons acting on its or their behalf (collectively, "Vishay"), disclaim any and all liability for any errors, inaccuracies or incompleteness contained herein or in any other disclosure relating to any product.

Vishay disclaims any and all liability arising out of the use or application of any product described herein or of any information provided herein to the maximum extent permitted by law. The product specifications do not expand or otherwise modify Vishay's terms and conditions of purchase, including but not limited to the warranty expressed therein, which apply to these products.

No license, express or implied, by estoppel or otherwise, to any intellectual property rights is granted by this document or by any conduct of Vishay.

The products shown herein are not designed for use in medical, life-saving, or life-sustaining applications unless otherwise expressly indicated. Customers using or selling Vishay products not expressly indicated for use in such applications do so entirely at their own risk and agree to fully indemnify Vishay for any damages arising or resulting from such use or sale. Please contact authorized Vishay personnel to obtain written terms and conditions regarding products designed for such applications.

Product names and markings noted herein may be trademarks of their respective owners.

Mouser Electronics

Authorized Distributor

Click to View Pricing, Inventory, Delivery & Lifecycle Information:

[Vishay:](#)

[ILD1206T](#) [ILD1205T](#) [ILD1207T](#)