

High Current Density Surface Mount Schottky Barrier Rectifiers



FEATURES

- Very low profile - typical height of 1.1 mm
- Ideal for automated placement
- Guardring for overvoltage protection
- Low forward voltage drop, low power losses
- High efficiency
- Low thermal resistance
- Meets MSL level 1, per J-STD-020, LF maximum peak of 260 °C
- AEC-Q101 qualified available
- Automotive ordering code: base P/NHM3
- Material categorization: for definitions of compliance please see www.vishay.com/doc?99912

TYPICAL APPLICATIONS

For use in high frequency rectifier of switching mode power supplies, freewheeling diodes, DC/DC converters, and polarity protection application.

MECHANICAL DATA

Case: TO-277A (SMPC)

Molding compound meets UL 94 V-0 flammability rating
Base P/N-M3 - halogen-free, RoHS-compliant, and commercial grade

Base P/NHM3 - halogen-free, RoHS-compliant, and AEC-Q101 qualified

Base P/NHM3_X - halogen-free, RoHS-compliant, and AEC-Q101 qualified (“_X” denotes revision code e.g. A, B,))

Terminals: Matte tin plated leads, solderable per J-STD-002 and JESD 22-B102

M3 suffix meets JESD 201 class 2 whisker test, HM3 suffix meets JESD 201 class 2 whisker test

PRIMARY CHARACTERISTICS	
$I_{F(AV)}$	5.0 A
V_{RRM}	90 V, 100 V
I_{FSM}	150 A
V_F at $I_F = 5.0$ A	0.649 V
I_R	4.5 μ A
T_J max.	150 °C
Package	TO-277A (SMPC)
Diode variations	Single

MAXIMUM RATINGS ($T_A = 25$ °C unless otherwise noted)				
PARAMETER	SYMBOL	SS5P9	SS5P10	UNIT
Device marking code		S59	S510	
Maximum repetitive peak reverse voltage	V_{RRM}	90	100	V
Maximum average forward rectified current (fig. 1)	$I_{F(AV)}$	5.0		A
Peak forward surge current 10 ms single half sine-wave superimposed on rated load	I_{FSM}	150		A
Non-repetitive avalanche energy at $I_{AS} = 2.0$ A, $T_J = 25$ °C	E_{AS}	20		mJ
Operating junction and storage temperature range	T_J, T_{STG}	-55 to +150		°C



ELECTRICAL CHARACTERISTICS ($T_A = 25\text{ }^\circ\text{C}$ unless otherwise noted)						
PARAMETER	TEST CONDITIONS		SYMBOL	TYP.	MAX.	UNIT
Instantaneous forward voltage	$I_F = 2.5\text{ A}$	$T_A = 25\text{ }^\circ\text{C}$	$V_F^{(1)}$	0.708	-	V
	$I_F = 5.0\text{ A}$			0.832	0.88	
	$I_F = 2.5\text{ A}$	$T_A = 125\text{ }^\circ\text{C}$		0.571	-	
	$I_F = 5.0\text{ A}$			0.649	0.68	
Reverse current	Rated V_R	$T_A = 25\text{ }^\circ\text{C}$	$I_R^{(2)}$	4.5	15	μA
		$T_A = 125\text{ }^\circ\text{C}$		2.7	5	mA
Typical junction capacitance	4.0 V, 1 MHz		C_J	130	-	pF

Notes

- (1) Pulse test: 300 μs pulse width, 1 % duty cycle
(2) Pulse test: Pulse width $\leq 40\text{ ms}$

THERMAL CHARACTERISTICS ($T_A = 25\text{ }^\circ\text{C}$ unless otherwise specified)				
PARAMETER	SYMBOL	SS5P9	SS5P10	UNIT
Typical thermal resistance	$R_{\theta JA}^{(1)}$	65		$^\circ\text{C/W}$
	$R_{\theta JL}$	3		

Note

- (1) Units mounted on recommended PCB 1 oz. pad layout

ORDERING INFORMATION (Example)				
PREFERRED P/N	UNIT WEIGHT (g)	PACKAGE CODE	BASE QUANTITY	DELIVERY MODE
SS5P10-M3/86A	0.10	86A	1500	7" diameter plastic tape and reel
SS5P10-M3/87A	0.10	87A	6500	13" diameter plastic tape and reel
SS5P10HM3/86A ⁽¹⁾	0.10	86A	1500	7" diameter plastic tape and reel
SS5P10HM3/87A ⁽¹⁾	0.10	87A	6500	13" diameter plastic tape and reel
SS5P10HM3_A/H ⁽¹⁾	0.10	H	1500	7" diameter plastic tape and reel
SS5P10HM3_A/I ⁽¹⁾	0.10	I	6500	13" diameter plastic tape and reel

Note

- (1) AEC-Q101 qualified

RATINGS AND CHARACTERISTICS CURVES ($T_A = 25\text{ }^\circ\text{C}$ unless otherwise noted)

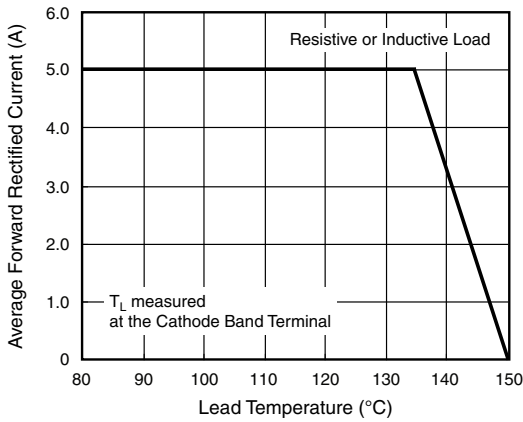

Fig. 1 - Maximum Forward Current Derating Curve

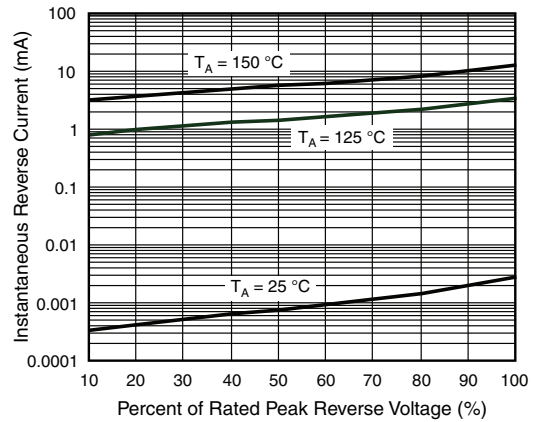

Fig. 4 - Typical Reverse Characteristics

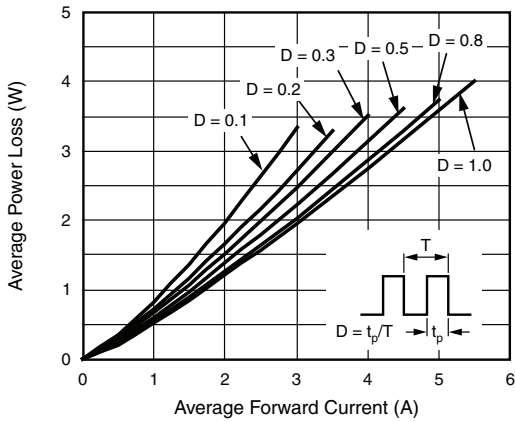

Fig. 2 - Forward Power Loss Characteristics

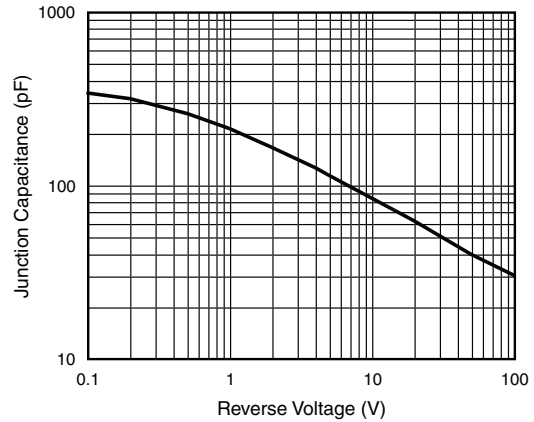

Fig. 5 - Typical Junction Capacitance

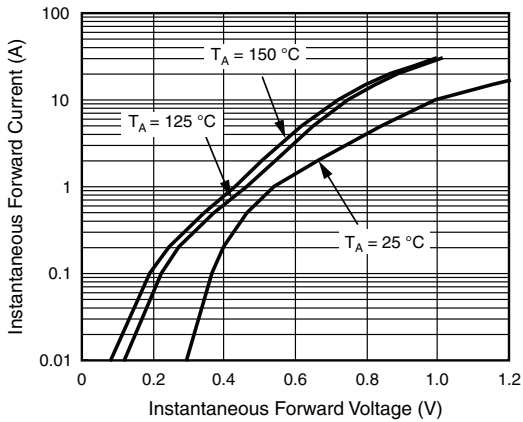

Fig. 3 - Typical Instantaneous Forward Characteristics

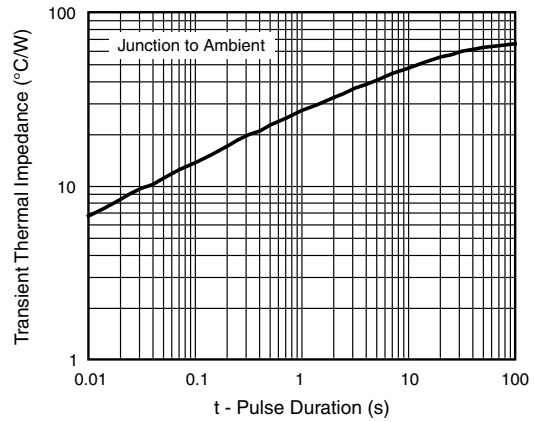
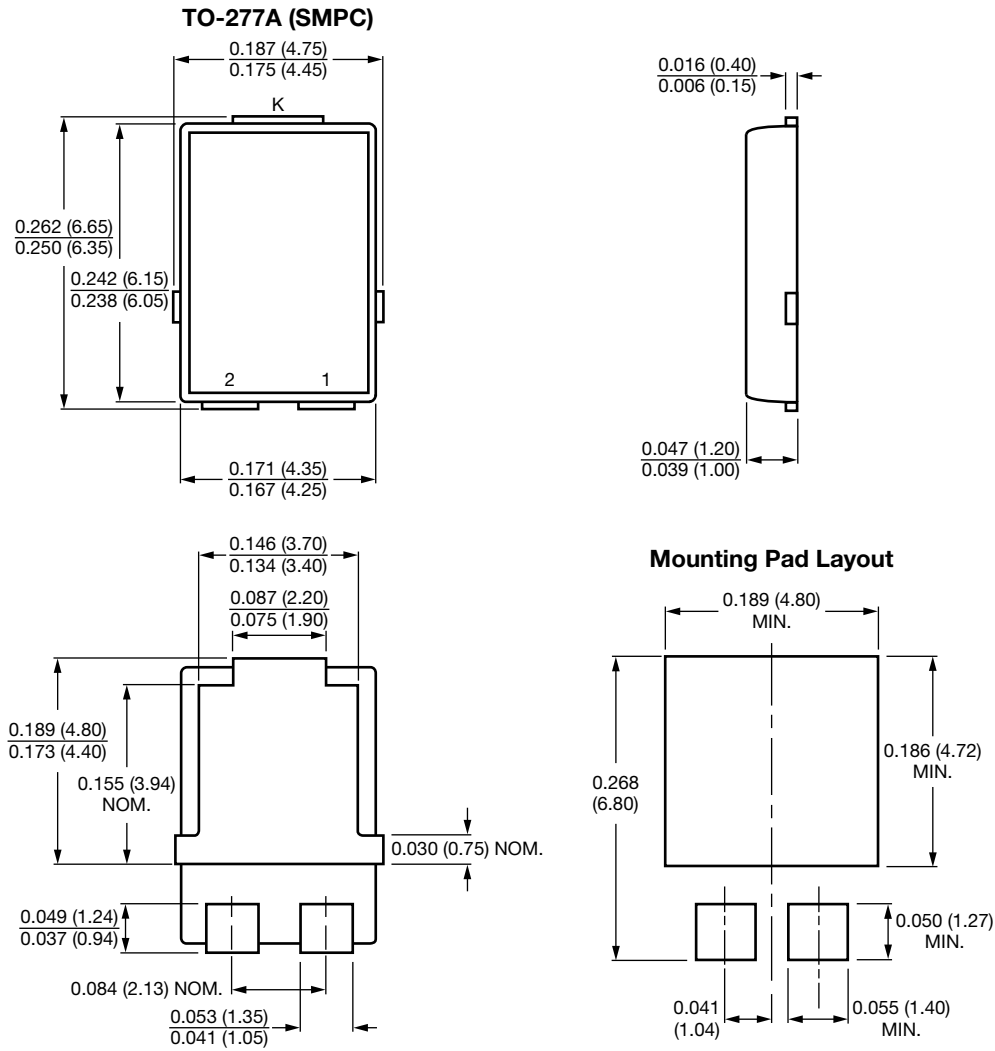

Fig. 6 - Typical Transient Thermal Impedance

PACKAGE OUTLINE DIMENSIONS in inches (millimeters)



Conform to JEDEC® TO-277A



Disclaimer

ALL PRODUCT, PRODUCT SPECIFICATIONS AND DATA ARE SUBJECT TO CHANGE WITHOUT NOTICE TO IMPROVE RELIABILITY, FUNCTION OR DESIGN OR OTHERWISE.

Vishay Intertechnology, Inc., its affiliates, agents, and employees, and all persons acting on its or their behalf (collectively, "Vishay"), disclaim any and all liability for any errors, inaccuracies or incompleteness contained in any datasheet or in any other disclosure relating to any product.

Vishay makes no warranty, representation or guarantee regarding the suitability of the products for any particular purpose or the continuing production of any product. To the maximum extent permitted by applicable law, Vishay disclaims (i) any and all liability arising out of the application or use of any product, (ii) any and all liability, including without limitation special, consequential or incidental damages, and (iii) any and all implied warranties, including warranties of fitness for particular purpose, non-infringement and merchantability.

Statements regarding the suitability of products for certain types of applications are based on Vishay's knowledge of typical requirements that are often placed on Vishay products in generic applications. Such statements are not binding statements about the suitability of products for a particular application. It is the customer's responsibility to validate that a particular product with the properties described in the product specification is suitable for use in a particular application. Parameters provided in datasheets and / or specifications may vary in different applications and performance may vary over time. All operating parameters, including typical parameters, must be validated for each customer application by the customer's technical experts. Product specifications do not expand or otherwise modify Vishay's terms and conditions of purchase, including but not limited to the warranty expressed therein.

Except as expressly indicated in writing, Vishay products are not designed for use in medical, life-saving, or life-sustaining applications or for any other application in which the failure of the Vishay product could result in personal injury or death. Customers using or selling Vishay products not expressly indicated for use in such applications do so at their own risk. Please contact authorized Vishay personnel to obtain written terms and conditions regarding products designed for such applications.

No license, express or implied, by estoppel or otherwise, to any intellectual property rights is granted by this document or by any conduct of Vishay. Product names and markings noted herein may be trademarks of their respective owners.

Mouser Electronics

Authorized Distributor

Click to View Pricing, Inventory, Delivery & Lifecycle Information:

[Vishay:](#)

[SS5P10-E3/86A](#) [SS5P10-E3/87A](#) [SS5P9-E3/86A](#) [SS5P9-E3/87A](#) [SS5P9-M3/87A](#) [SS5P9-M3/86A](#) [SS5P10-M3/87A](#)
[SS5P10-M3/86A](#) [SS5P10HM3_A/H](#) [SS5P9HM3_A/H](#) [SS5P10HM3_A/I](#) [SS5P9HM3_A/I](#) [SS5P9HM3/86A](#)
[SS5P9HM3/87A](#) [SS5P10HM3/87A](#) [SS5P10HM3/86A](#)